

RESOPLAN®

PROCESSING INSTRUCTIONS

The architectural board for external application

REINVENT *with* **RESOPAL**



Resopal develops more than just products: In close co-operation with our customers, we create solutions and concepts for the modern design of spaces and surfaces. We are pioneers in the area of super-compacted laminates. Patented back in 1930, RESOPAL® is characterised by one of the hardest surfaces and today still stands for long-lasting quality.

The broad pallet of colours, decors and formats allows an almost unlimited range of design possibilities: from cool and urban to warm and natural; from harmonious tone in tone to strikingly accentuated, including all shades in between. You have the choice. Depending on the requirement, with RESOPLAN the building fits harmoniously into the environment or catches the eye due to striking contrasts.

RESOPLAN allows various types of fixings and different joints. The facade boards are suitable for the design of larger properties and smaller details, from apartment buildings to industrial premises, in new builds and in renovations. Apart from its use as mounted, rear-ventilated facades, there are a large number of possible applications, for example, as cladding on balcony parapets or as sun protection.

Use RESOPLAN in your next property - this brochure contains planning and implementation instructions. And whenever you need additional information, we look forward to your call or email.

I. PRODUCT & FEATURES	06	VII. VISIBLE FIXING ON	36
Product design and areas of application	06	WOODEN BASE STRUCTURE	
Certifications	07	General information	36
Sizes and Thicknesses		Components of the base structure	37
Aesthetic recommendation		Fixing points	38
Decors	08	Distances between screw fixings	39
Technical Data	09	Details of wooden base structure	40
II. STORAGE AND PROCESSING	10	VIII. CONCEALED FIXING ON	42
Packaging and storage	10	WOODEN BASE STRUCTURE	
Handling	10	General information	42
Cut		Fixing with screws	43
Edge machining	12	Fixing with brackets	
Drilling	13	Details of clapboard fixing with screws	44
Disposing of waste		Details of clapboard fixing with brackets	46
Cleaning and maintenance		IX. MATERIAL COMBINATIONS	48
III. FACADE APPLICATIONS	14	General information	48
Applicable standards and certificates	14	Details of the facade sections	49
Areas of application and fire classification	15	X. FACADE SECTIONS	50
General assessment bases		General information	50
Maximum distances between fixings and to edges	16	Details of the facade sections	51
Breathing and ventilation of the rear-ventilated cavity		XI. CEILING CLADDING	52
Unforced assembly		General information	52
Joints and corners		Distances between fixings	
Curved boards	17	Details of ceiling cladding	53
IV. VISIBLE FIXINGS ON	18	XII. BALCONIES	54
METAL BASE STRUCTURE		General information	54
General information	18	Fixing with rivets or screws	55
Components of the base structure	19	Fixing panel-format	56
Fixing points	20	Balcony cladding	
Distances between rivet fixings	21	Fixing with straps and screws	57
Details of the metal base structure	22	Fixing with panel frame	
V. CONCEALED BONDED FIXING	24	XIII. SUN PROTECTION	58
ON METAL BASE STRUCTURE		General information	58
General information	24	Fixing	59
Components of the base structure	25	XIV. WINDOW SHUTTERS	60
Components of the bonding fixing	25	General information	60
Processing	25	Fixing	61
Details of bonding on a metal base structure	26	SOURCES OF SUPPLY	62
VI. CONCEALED MECHANICAL FIXING ON A METAL	28		
BASE STRUCTURE			
General information	28		
Components of the base structure	29		
Fixing points	30		
Distances between fixings for concealed fixing	32		
Details of the concealed fixing on metal base structure	34		



CONTENT

I.

PRODUCT & FEATURES

RESOPLAN boards are decorative high-pressure laminates (HPL) in accordance with EN 438, which are available in a broad range of decors, formats and thicknesses. Consequently the facadeboards offer a large amount of design freedom. Because of the simple processing and the low weight of the RESOPLAN boards, installation is quick and safe, and waste can be kept to a minimum thanks to the variety of formats.

PRODUCT DESIGN AND AREAS OF APPLICATION

The high-pressure laminate (HPL) is manufactured on the basis of paper (65 %) and thermosetting and water-based resin (35 %). An appropriate outer layer (coating) is applied to both sides of the decorative surface in order to ensure weather and light-protective features, which are used in vertical applications such as facade claddings, balcony claddings or window shutters, as well as for outdoor soffits, facade sections and as sun protection.

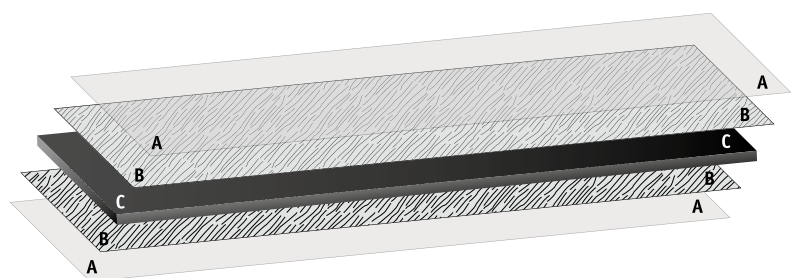

CERTIFICATIONS

RESOPLAN is extremely weather-resistant EDS/EDF-type boards in accordance with EN 438 Part 6 for external use. We have the CE-certification required for sales of the boards.

Application as low-flammable facade boards is regulated in the National Technical Approval from the *Deutsches Institut für Bautechnik*. The National Technical Approval includes visible fixing with rivets and screws and concealed fixing with adhesives. European Technical Approval (ETA) has been granted for concealed fixing. RESOPLAN boards are PEFC-certified.

SIZES AND THICKNESSES

	RESOPLAN		RESOPLAN MOTIV	
	Production size	Effective size	Production size	Effective size
Size	3050 mm x 1320 mm 3650 mm x 1320 mm 2180 mm x 1020 mm	3040 mm x 1310 mm 3640 mm x 1310 mm 2170 mm x 1010 mm	3050 mm x 1320 mm 3650 mm x 1320 mm 2180 mm x 1020 mm	2960 mm x 1260 mm 3560 mm x 1260 mm 2090 mm x 0930 mm
Thickness	6, 8, 10, 12 mm and 3 mm for composite elements (roughened on rear)		6, 8, 10, 12 mm and 3 mm for bonded boards (roughened on rear)	
Texture	60 Matte - dirt-resistant, good reflection values		60 Matte - dirt-resistant, good reflection values	
Building material class	B1 (RESOPLAN F) according to DIN 4102-1 and B2 (RESOPLAN) according to DIN 4102-1 Euroclass according to EN 13501-1: B-s2, d0 (RESOPLAN F) and D-s2, d0 (RESOPLAN)		B1 (RESOPLAN F) according to DIN 4102-1 and B2 (RESOPLAN) according to DIN 4102-1 Euroclass according to EN 13501-1: B-s2, d0 (RESOPLAN F) and D-s2, d0 (RESOPLAN)	









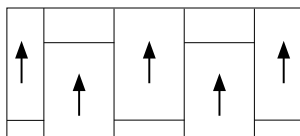
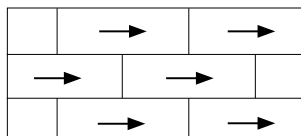



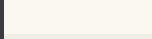
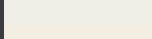
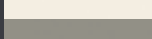
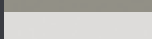



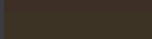

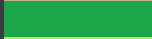



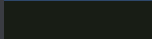



The production sizes follow the admissible tolerances of the length according to EN 438 of -0/+10 mm and the perpendicularity of 1.5 mm/m. In order to achieve higher dimensional precision, cutting the boards to at least two adjacent sides is recommended. The effective sizes are therefore reduced by 10 mm.









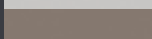
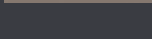
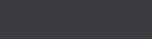
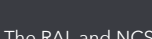
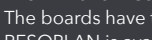
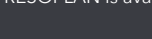
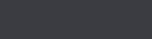



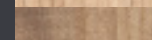

AESTHETIC RECOMMENDATION





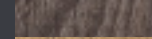

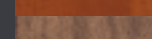
A uniform installation direction is recommended for the wood, stone and minerals decors and for dark coloured decors (horizontal or vertical).

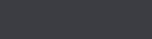
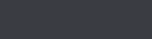
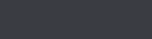

DECORS

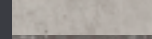
Colours				
	NO.	DECOR	NCS	RAL
	P00104	Traffic White	S 0502 R50B	9003
	P00105	Pearl White	S 0502 Y	9010
	P00135	Rain	S 1002 G	7035
	P00140	Dawn	S 1002 Y	9002
	P00150	Tin	S 4502 Y	7030
	P00160	Silver Grey	S 2000 N	7035
	P00168	Azul	S 2005 R70B	9003
	P00300	Infinity	S 2070 Y90R	3000
	P00310	Brick	S 4550 Y70R	0504040
	P00340	Zinnia	S 3050 Y50R	8023
	P00520	Beaver	S 0810 Y50R	8010
	P00547	Chocolate	S 8005 Y20R	0602005
	P00565	Antilope	S 3010 Y30R	0607020
	P00600	Button	S 2060 G20Y	1406050
	P00634	Delicious	S 1040 G60Y	1108050
	P00665	Moss	S5020 G50Y	1105020
	P00743	Pacific	S 2050 R90B	5012
	P00767	Majestic	S 4550 R70B	2803035
	P00781	Soiree	S 6020 R80B	5000
	P00901	Black	S 9000 N	8022
	P01503	Putty	S 1505 Y10R	1009010
	P09429	Parrot	S 2050 G40Y	1105020
	P09440	Navy	S 6030 R80B	5013
	P09450	Teal	S 5040 B10G	2203030
	P09497	Ultramarine	S 3060 R80B	2604040
	P10542	Storm	S 6502 B	2604005
	P10622	Ebony	S 8000 N	7024
	P1500N	Soft Grey	S 2502 Y	7044
	P00D14	Port	S 4550 Y90R	3032
	P0D354	Designer White	S 0603 R80B	9003
	P0D378	Clear Teal	S 3020 B50G	6034
	P0D421	Midori	S 6030 B70G	6004
	P0D475	Baltic Sea	S 4030 R90B	5014
	P0D483	Yellow	S 5060 Y	1018
	P00D73	Pewter	S 4502 B	7001
	P00D90	North Sea	S 5502 G	7035
	P00D92	Dove Grey	S 3000 N	7047
	P00D96	Shadow	S 5005 Y50R	7006

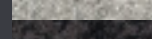
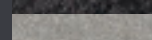
Woods		
	NR.	DEKOR
	P04109	Piave Cherry
	P04110	Wenge Nakuru
	P04116	Delicious Oak
	P04118	Novara Elm
	P04123	Cottage Pine
	P04129	Washy Elm
	P04134	Mississippi Pine
	P04165	Solano Oak
	P04166	Valley Oak
	P04167	Diego Oak
	P04168	Pablo Oak
	P04228	Silver Oak
	P04289	Vintage Oak
	P04335	Mountain Lodge
	P04344	Rustic Oak
	P04425	Sun Teak
	P04428	Delight Cherry
	P04447	Noce Romantica
	P04448	Unique Elm
	P04490	Zebrano Nightfall

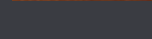
Stones and Minerals		
	NO.	DECOR
	P03207	Finery
	P03236	Eternal Iron
	P03447	Cloudy Cement
	P03533	Ruby Limescale
	P03540	Granic Vein
	P04939	Patina Rock
	P04943	Empire Slate
	P04944	Corten

The RAL and NCS Codes information are approximate values.
The boards have the same decor on both sides.
RESOPLAN is available with Matte (60) texture.

TECHNICAL DATA

FEATURE	STANDARD	UNIT	EDS	EDF
Physical properties and dimensions				
Thickness	ISO 1183	g/cm ³		≥ 1,4
Thickness tolerance	EN 438-2-5	mm	6 mm: ± 0,4 / 8 +10 mm: ± 0,5/ 12 mm: ± 0,6	
Length and width tolerance	EN 438-2-6	mm	+ 10 / - 0	
Tolerance of edge straightness	EN 438-2-7	mm/m	≤ 1,5	
Tolerance of perpendicularity	EN 438-2-8	mm/m	≤ 1,5	
Tolerance of flatness	EN 438-2-9	mm/m	6 + 8 mm: ≤ 5 / 10 + 12 mm: ≤ 3	
Dimensional stability at increased temperature (70oC and 40oC at 90-95% humidity)	EN 438-2-17	2 mm ≤ t ≤ 5 mm		≤ 0,4
• Longitudinal		%		≤ 0,8
• Transverse		t ≥ 5 mm		
• Longitudinal		%		≤ 0,3
• Transverse		%		≤ 0,6
Mechanical properties				
Flexural modulus	EN ISO 178	MPa		≥ 9000
Flexural strength	EN ISO 178	MPa		≥ 80
Surface properties / Ageing resistance				
Surface resistance (anti-static)	DIN EN 61340-2-3	Ω (no static charge)		10 ⁹ - 10 ¹¹
Resistance against UV radiation (1500 hrs)	EN 438-2-28			
• Contrast		Grey scale Degree (from 1 to 5)		≥ 3
• Appearance				≥ 4
Resistance against artificial weathering (3000 hrs)	EN 438-2-29			
• Contrast		Grey scale Degree (from 1 to 5)		≥ 3
• Appearance				≥ 4
Resistance against moisture (48 hours in warm water at 65oC)	EN 438-2-15	Increase in size %		
• Increase in size		2 ≤ t ≤ 5	≤ 7	≤ 10
• Appearance		t ≥ 5	≤ 5	≤ 8
		Appearance Degree	≥ 4	≥ 4
Resistance against fast changes in weather	DIN EN 438-2-19			
• Appearance		Degree (from 1 to 5)		≥ 4
• Flexural strength index Ds				≥ 0,8
• Flexural modulus				≥ 0,8
Fire behaviour				
RESOPLAN®	DIN 4102-1		B2	
RESOPLAN® F	DIN 4102-1			B1
RESOPLAN®	EN 13501-1		D-s2, d0	
RESOPLAN® F	EN 13501-1			B-s2, d0
Calorific value	DIN 51900	MJ/kg		18-20
Thermal longitudinal expansion coefficient	DIN 51045 (+80/-20)			
• Longitudinal		1/K		0,9 * 10 ⁻⁵
• Transverse		1/K		1,6 * 10 ⁻⁵

EDS: E (External application), D (Strong load), S (Standard quality)

EDF: E (External application), D (Strong load), F (Flame-retardant)

Degree: 5: No visible change, 4: Only change to degree of shine, 3: Hairline cracks and/or appearance of erosion on the surface, 2: Surface cracks, 1: Blisters and/or delamination.



II.

STORAGE & PROCESSING

PACKING & STORAGE

In order to prevent damage to RESOPLAN during packaging and storage, please note a few fundamental things.

- Use flat and stable pallets with dimensions that at least correspond to those of the facade boards, in order to prevent any slipping and overhanging.
- Store the boards in a closed area, which is protected against moisture and heat, in order to prevent irreversible deformation (18 to 25 °C and 50 to 65 % relative humidity).
- Use a sufficiently large cardboard layer between pallet and board. Always cover and weigh-down the tops of pallet stacks.
- Store the boards flat in order to prevent deformation.
- We do not recommend storage outside. However, if this is the case, place a tarpaulin over the boards.
- Protect against dirt, moisture and mechanic damage.
- Because of condensation, do not seal the pallet stack with film.

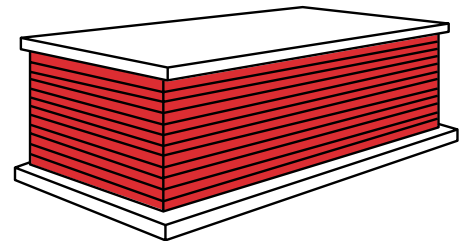

HANDLING

In order to ensure the perfect quality of the decorative surface, the RESOPLAN boards must be treated with care. The following procedure is recommended:

- Use a forklift with a capacity of at least 2.5t and a tine length of 1.5 m to unload the pallets.
- When moving the boards, lift them one at a time in order to avoid scratching the surface.
- Do not allow the decorative surfaces to rub against each other. When moving the boards by hand, it is recommended that larger formats are handled by multiple persons. Please observe occupational health and safety guidelines. If using a mechanical handling system, vacuum lifter can be used.
- Ensure that the boards are free from dirt and abrasive particles.



Lift the boards and do not slide them from the stack!

PALLET WEIGHTS

Board dimensions		Area / board	Board thickness	Weight / board	Number of boards / pallet	Area / pallet	Weight / pallet
Length	Width						
m	m	m ²	mm	kg	pcs	m ²	kg
2,18	1,02	2,22	6	19,08	20	44,5	412
			8	25,44	20	44,5	539
			10	31,80	20	44,5	666
			12	38,16	10	22,2	412
3,05	1,32	4,03	6	34,54	24	96,6	879
			8	46,06	24	96,6	1155
			10	57,57	16	64,4	971
			12	69,09	8	32,2	603
3,65	1,32	4,82	6	41,34	20	96,4	892
			8	55,12	20	96,4	1167
			10	68,90	20	96,4	1443
			12	82,68	10	48,2	892

CUT

Board dimensions and use dimensions

The RESOPLAN boards are delivered trimmed. The dimensional accuracy and perpendicularity of the boards correspond to the requirements of DIN EN 438. It is recommended that the boards be cut to size at right angles in order to be able to fulfil the maximum requirements for accuracy of the cut boards. This reduces the effective size of the boards by 10 mm in each direction (for example: Board size: 3050 × 1320 mm, max. effective size: 3040 × 1310 mm).

- Carbide-edged tools are needed to cut RESOPLAN. For larger quantities, diamond-edged tools are preferable.
- To cut facade boards, the following machines can be used: table saws, hand-held circular saws or industrial pressure bar or vertical saws, as well as CNC-controlled machines.

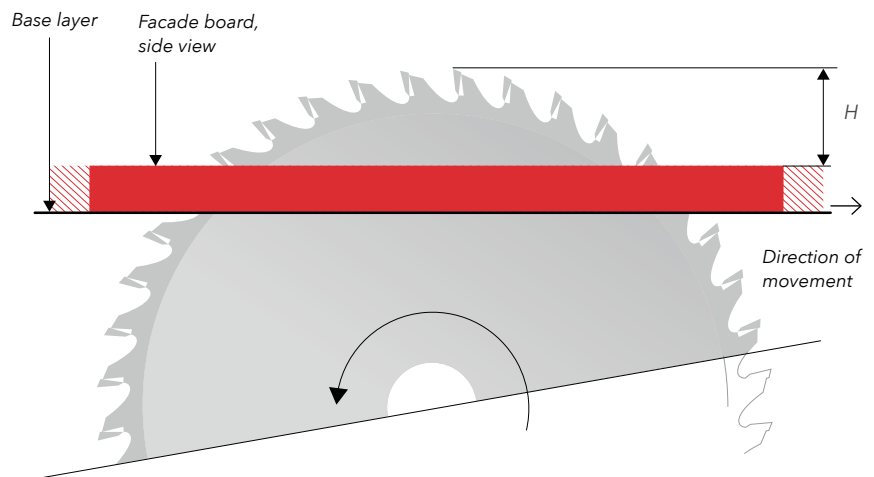

Table and format circular saw cut

H = 15 - 20 mm
H = cutting depth

RESOPLAN boards can be worked like hardwood with standard hardwood processing tools.

RECOMMENDED MACHINES

HAND-HELD CIRCULAR SAWS

It is recommended that carbide or diamond-edged blades be used to cut from the back of the board.

INDUSTRIAL SAWS

Carbide or diamond-edged blades with a large diameter (e.g. 200 mm). In order to optimise the cut quality on both sides, use of a pre-scoring is recommended so that there is a good edge cut on both decor sides. Fix the boards to prevent vibrations. Ideally, use blades with alternating flat or trapezoid teeth. In any case, adjust the feed rate of the saw to the desired cut quality and thickness of the board.

CNC-CONTROLLED MACHINES

Carbide or diamond-edged cutting tools. Recommended speed between 18,000 and 24,000 rpm. This allows cutting on both sides without splitting the decor, without having to use a board as a base layer.

Type of saw	Blade diameter (mm)	Number of teeth	Saw speed (rpm)	Cutting depth (mm)	Feed rate (m/min)
Manual	160	48	4000 U/min	16	4 m/min
Manual	180	48	4000 U/min	18	4 m/min
Industrial	200	72	9000 U/min	20	6 m/min
Industrial	280	72	9000 U/min	28	6 m/min
Industrial	300	72	9000 U/min	30	6 m/min
Industrial	330	72	9000 U/min	33	6 m/min
Industrial	350	72	9000 U/min	35	6 m/min
Industrial	360	72	9000 U/min	36	6 m/min
Industrial	380	72	9000 U/min	38	6 m/min
Industrial	400	72	9000 U/min	40	6 m/min
Industrial	420	72	9000 U/min	42	6 m/min
Industrial	450	72	9000 U/min	45	6 m/min



Trapezoid flat teeth

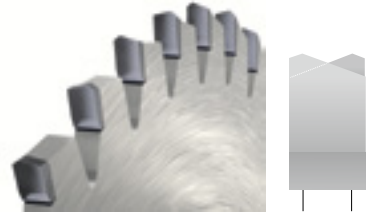

Alternating teeth

EDGE MACHINING

It is recommended that sharp edges are broken in order to prevent injuries when laying or installing.

In order to give the edges a specific shape, the edges can be easily machined. The cut edges do not require specific treatment, e.g. waterproofing.

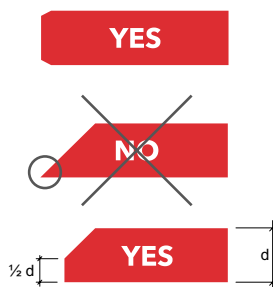

DO YOU HAVE ANY QUESTIONS?

Then contact your sales advisor, send us an email to info@resopal.de or visit our homepage at www.resopal.de

Technical information is provided for you there.

DRILLING

Manual drilling

- Ensure that the speed is set correctly in order to prevent splitting or overheating.
- Push the drill forwards without impact.
- It is advised that you work on a base layer, through which the drill can bore (e.g. hardwood board, chipboard or MDF board).
- The chapter "Concealed fixing on metal base structures" contains information about blind holes.

CNC-controlled drilling

- Recommended speed between 18,000 and 24,000 rpm.
- The board must be tightly secured in order to prevent any vibration.

The use of carbide or diamond-tipped drills is recommended.



DISPOSING OF WASTE

Energy recovery

Because of its high calorific value (18-20 MJ/kg), RESOPLAN boards are particularly good for thermal reuse. They burn at 700°C to completely burn out to form water, carbon dioxide and nitrogen oxide. RESOPLAN therefore offers the conditions for reuse for energy generation according to s.8 German Waste Management and Product Recycling Act. The conditions for good combustion processes in modern, officially licensed industrial combustion plants are guaranteed. The ash from these combustion processes can be transported to controlled landfill sites.

CLEANING AND MAINTENANCE

Energy recovery

RESOPLAN boards are simple and because of their homogenous and pore-less surface do not require care. However, after machining and processing, or over time, cleaning may be necessary. The cleaning recommendations apply to surface dirt that arises during general use, during machining and installation.

General Cleaning

Lighter dirt can be easily cleaned with clear, lukewarm water. Heavier dirt can be removed with soap or detergent solution.

- Use non-abrasive domestic detergent always diluted in water.
- Use fine and clean cloths or sponges.
- Always rinse with clean, clear water in order to prevent smearing.

Waste disposal

RESOPLAN boards can be transported to controlled landfill sites that currently correspond to the national and/or regional conditions.

Remnants and off-cuts are covered by waste codes 03 01 05. Sawdust has to be classed under waste codes 03 01 04.

The following detergents must never be used

- Abrasive detergents (e.g. scouring powder or scouring agent).
- Solvents or cleaners containing solvents (e.g. acetone, white spirit, dilutions, etc.).
- Scouring or abrasive cloths (e.g. microfiber cloths, scouring pads, steel wool, etc.).
- High-pressure cleaners or steam cleaners.

It is recommended that the detergent be tested before use. Please note the manufacturer's instructions. Resopal GmbH is not liable in the event of incorrect cleaning or incorrect use of detergents.



III.

FACADE APPLICATIONS

The mounted, rear-ventilated facade system has been proven in practice for decades. It primarily comprises the following components:

- The base structure (ideally made from aluminium or wood) anchored to the supporting building construction in order to hold the dead weight of the cladding material and the wind loads experienced by the building.
- The mineral thermal insulation (if required)
- The rear-ventilation space for constructive separation from the thermal insulation and weather protection, as well as for climate and moisture regulation of the building
- The cladding material as design element and weather protection for the building, including accompanying fixing elements

APPLICABLE STANDARDS AND CERTIFICATES

RESOPLAN boards are CE-certified, high-pressure laminate boards (HPL), manufactured according to DIN EN 438. Their use in the facade and as soffits outside is governed by the National Technical Approval from the Deutsches Institut für Bautechnik or European Technical Approval (ETA). When planning and implemented mounted, rear-ventilated facades, the applicable standards and provisions, as well as the respective national building regulations, must be observed.

AREAS OF APPLICATION AND FIRE CLASSIFICATION

RESOPLAN is classed as a low-flammable facade cladding (B-s2, d0 according to DIN EN 13501-1). The usability of the facade boards is governed in the Model Building Code and in the respective state building regulations of Federal Republic of Germany. In high-rise buildings, except for special structures, RESOPLAN boards can be used up to building class 5. This includes buildings, whose floors with the highest rooms are not higher than 22 mm. Both metal and wood can be used as material for the base structures.

The building regulations applicable in Austria and Switzerland differ from the guidelines applicable in Germany. To use RESOPLAN in Austria and Switzerland, the local building regulations, including "ÖiB-Richtlinie 2 - Brandschutz OIB-330.2" (Austrian Directive 2 Fire Protection OIB-330.2) for Austria and "Brandschutzrichtlinie" (Fire safety directive) for Switzerland, published by the "Vereinigung Kantonale Feuerversicherungen (VKF)", according to the respective latest version, must be checked and complied with.

Fire locks

For buildings in building classes 4 and 5, specific measures have to be taken against the spread of fire (fire locks) according to s. 28 para. 4 Model Building Code for Exterior Wall Structures. According to Annex 2.6/4 to DIN 18516-1 in MLTB, the thermal insulation of external wall structures with intra-storey cavities, must not be flammable.

Horizontal fire locks are not required in external walls without openings according to the model list of technical approvals. If the spread of fire in the rear-ventilation cavity is prevented by the type of window arrangement (e.g. continuous window hinges, intra-storey window elements), horizontal fire locks are not required.

GENERAL ASSESSMENT BASES

The stability of the facade cladding must be proven or provable in relation to the property. All parts of the facade cladding have to be assessed with the safeties and admissible stresses of the corresponding standards, design certifications or technical approvals.

Resistance against wind loads according to DIN EN 1991-1-4 (Eurocode 1) and the national application document must be proven. For buildings with mounted, rear-ventilated facades (VHF), reduced wind loads can be applied to the facade boards if the external wall cladding is deemed to be wind permeable (according to Eurocode 1). When calculating the cross-section sizes, DIN 18516-1 has to be taken into account.

The calculation values of the dead load, the admissible flexural stress and the modulus of elasticity for the facade boards and the admissible loads of the fixing elements are contained in the National Technical Approval from the *Deutsches Institut für Bautechnik* (including: design certification). For concealed (not visible) fixing, the European Technical Approval for this type of fixing has to be observed.

Additional loads, e.g. from signs, must not be transferred into the facade boards, but instead have to be transferred directly into a base structure, which is fixed to the supporting structure of the building. Assembly, which exercises damaging distortions into the boards, must be omitted.

MAXIMUM DISTANCES BETWEEN FIXINGS AND TO EDGES

Structurally, the maximum distance between fixings for 600 mm RESOPLAN boards at 6 mm, for 700 mm at 8 mm and for 800 mm at 10 or 12 mm thickness must not be exceeded. Smaller distances between fixings may result from the property-related stability verification. The distances from the fixing to the edge of the board of at least 20 mm and not more than 10-times the board thickness must be complied with.

BREATHING AND VENTILATION OF THE REAR-VENTILATED CAVITY

In order to keep the structure permanently dry, thereby protecting it from rain, dew or building moisture, there must be a complete rear-ventilation cavity with sufficiently large breathing and ventilation openings. According to DIN 18516, the distance between facade board and wall or thermal insulation is at least 20 mm. This may be reduced locally, e.g. as a result of a base structure, or due to wall unevenness, to 5 mm. The breathing and ventilation openings at the lower and upper wall ending, as well as at windows and doors, must be at least 50 cm²/m. At the base, ventilation grids are required for openings above 20 mm according to DIN 18516 as protection against small animals, such as rodents. For rear-ventilated RESOPLAN facades, boards with a maximum board width of 12 cm without rear ventilation may also be installed in some areas.



UNFORCED ASSEMBLY

RESOPLAN boards, like their natural raw material wood, react to fluctuations in humidity with a change in volume. In addition, there are also volume changes in the facade application as a result of temperature changes. This change becomes noticeable above all in the direction of the board plane. In order to ensure board movement independent of the base structure, the boards are fixed without force. This is achieved with mechanical fixing with rivets or screws through the use of one fixed or multiple sliding points per board. The property-related structural calculation has to be observed here.

The fixed point fixes the board and serves to absorb vertical loads from the dead weight. The fixed points designed as sliding points allow load transfer from horizontal loads (wind loads) and at the same time ensure the required movement possibility for the facade boards. To form sliding points, the diameters of drill holes are larger than the diameters of the fixing elements (rivets or screws). In addition, when using rivets as fixing elements, a rivet jig is used when setting the sliding point. The fixed point is always positioned in the middle so that the movement is equally possible in all directions. In narrow boards, which only need two rows of fixings in the vertical or horizontal direction, the fixed point is fitted at the middle height of the board edge. The position of the fixed point or points within a facade area should always be chosen in the same position.

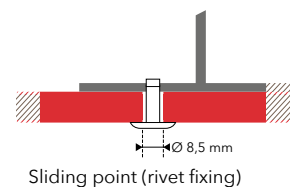
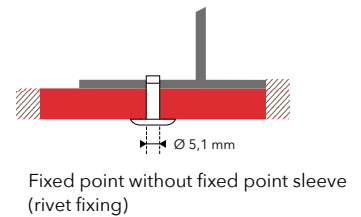
For concealed fixings, in order to secure the position (because of temperature and moisture-related movements by the mounted facade board) a clasp is made with U-profile sections and is connected with a fixing screw to the support profile, thereby preventing movements. The movement of the other clasps is not hindered.



-  Fixed point
-  Sliding point

H = Horizontal fixing distance
 V = Vertical fixing distance
 G = Distance from edge to fixing
 $\geq 20 \text{ mm}$ and $\leq 10 \times \text{board thickness}$

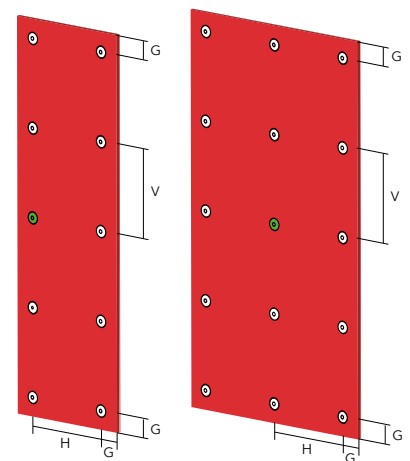

Arrangement of fixed and sliding points in a vertical base structure

JOINTS AND CORNERS

Apart from sliding points for the fixings, the joints secure the unforced expansion of the facade boards. To this end, and in order to form consistent joints as design elements, all joints must have a width of 10 mm.

It is generally not necessary to close the facade's joints. Any incoming moisture is safely removed as a result of the continuous airflow in the rear-ventilation cavity. It is possible to close horizontal joints by creating so-called fillisters in order to prevent dirt entering the rear-ventilation cavity, especially for nurseries or schools. It is recommended that the joints are only closed in the lower area of the facade because dirt stains from dust accumulating in the joint, are encouraged by closed joints.

The outer and inner corners of the facade can either with or without corner profiles. Sufficient movement possibilities for the boards must be ensured here. Joints with a width of 5 mm are technically sufficient for bluntly closed corners or joint profiles.

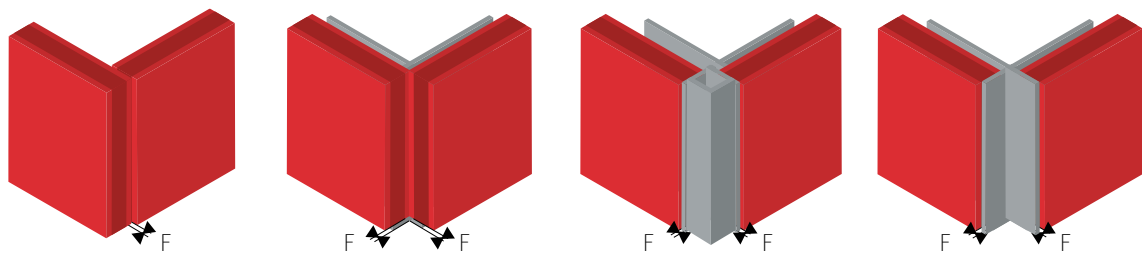

Joint width $F = 5 - 10$ mm

CURVED BOARDS

RESOPLAN boards can be curved with a radius of ≥ 1500 mm for 6 mm and ≥ 4000 mm for 8 mm boards. They can be fitted with screws or rivets to a vertical or previously curved horizontal supporting structure.

The additional forces resulting from the deformation of the facade boards must be taken into account in the proof of stability of the facade components. The mounting of the boards as a curved element is not included in the National Technical Approval from the *Deutsches Institut für Bautechnik* (future: design certification).

In order to estimate the number of fixings, the following recommendations can be assumed. The distance between the vertical support profiles should be reduced by 50%

compared to the numbers for a flat board. The distance between fixings on the supporting profiles should be reduced by 25%.

- Length of the curved edge: ≥ 1000 mm
- Length of the straight edge (perpendicular to the curved edge): $120 \text{ mm} \leq x \leq 500 \text{ mm}$
- Curve radius:
 - Board thickness 6 mm: Curve radius ≥ 1500 mm
 - Board thickness 8 mm: Curve radius ≥ 4000 mm

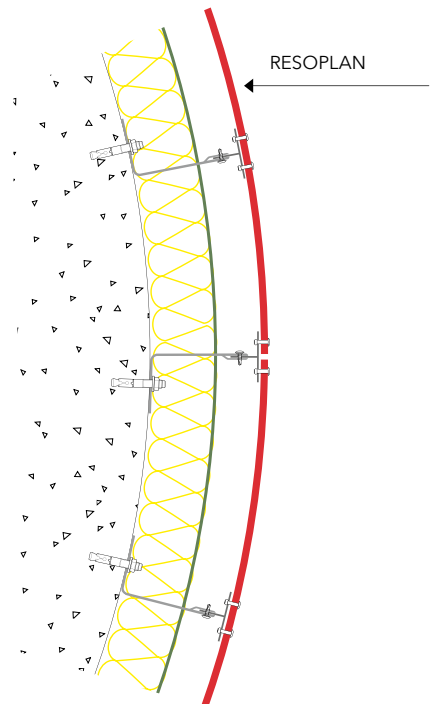

IV.

VISIBLE FIXINGS ON METAL BASE STRUCTURE

Mounting RESOPLAN on a metal base structure and fixing it with rivets, which are available in the same colour as the boards, is a permanent, high-quality and economic solution for new builds or renovations.

GENERAL INFORMATION

The use of RESOPLAN boards on a metal base structure, fixed with rivets, is governed in the National Technical Approval from the *Deutsches Institut für Bautechnik* (future: design certification) and thus offers the greatest security in the planning and implementation of the facade.

In addition, complying with the structural principles of the applicable standards, including DIN 18156, Rear-ventilated external wall cladding, the functional safety and the longevity of the facade structure are guaranteed.

The sufficiently large free ventilation cavity of at least 20 mm with a breathing and ventilation cross-section of 50 cm²/m guarantees the functional safety of the facade structure. The maximum distance between fixings (H) of 600 mm for 6 mm boards, 700 mm for 8 mm and 800 mm for 10 and 12 mm boards must not be exceeded. The facade boards are overwhelmingly fixed to vertically running support profiles. The load transfer to the base structure can be through various base structure models available on the mar-

ket. Depending on the project-specific requirements, a selection can be made from a large number of base structure systems and different materials available on the market, e.g. wall mounts, which depending on the material can be fitted with thermal separator elements, frame plugs or mullions.

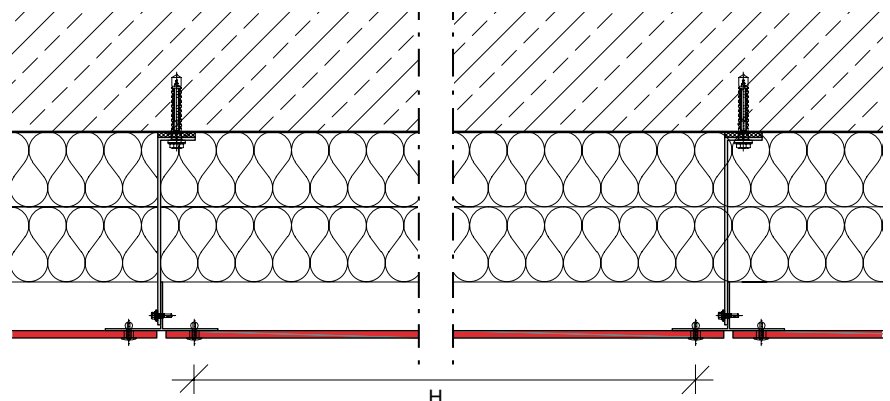

COMPONENTS OF THE BASE STRUCTURE

Supporting profiles

With standard supporting profiles, a profile thickness of at least 1.5 mm is required. At the board joint, T-profiles with a width of at least 100 mm are recommended. L-profiles should have a width of at least 40 mm. In order to prevent unwanted reflected light from the untreated UK profiles, black-coated supporting profiles are recommended. The supporting profiles should be mounted in a vertical direction in order to ensure the optimum rear-ventilation.

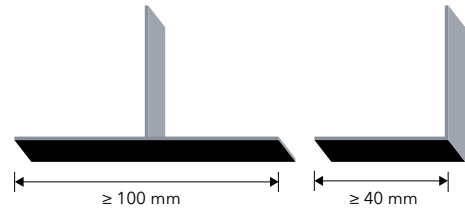

Wall mounts

When using aluminium wall mounts, there must be a distinction between fixed and sliding points. In addition to horizontal loads from wind, the fixed points absorb the load from the dead weight. The sliding point absorbs horizontal loads and ensures unforced movement is possible for the supporting profiles, which can occur due to changes in temperature. In addition, binders are used in the longitudinal holes. The movement possibilities in the joints of the base structure must also exist in the facade boards. As a result, the boards must not be mounted across the movement joints of two supporting profiles (in one fixing row).

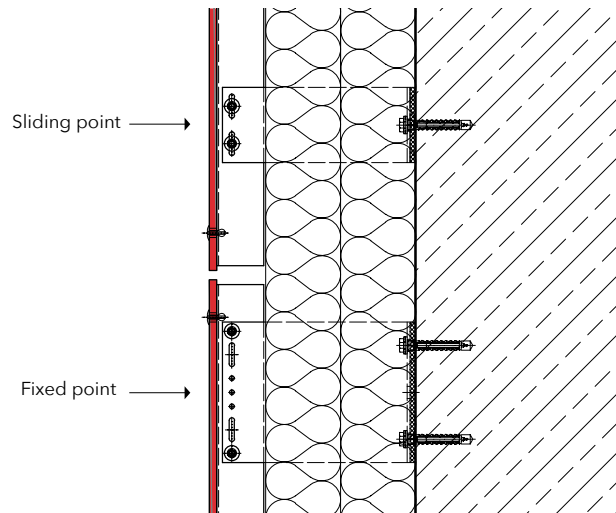

It must be ensured that a facade board is only fixed to supporting profiles, for which the wall mounts, which are designed as fixed points, are at the same height. This makes it necessary to separate supporting profiles, e.g. to the side of windows.

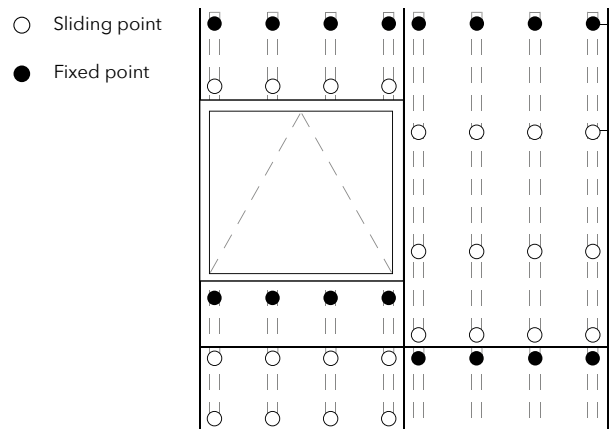

FIXING POINTS

Fixings

The fixings described in the National Technical Approvals from the *Deutsches Institut für Bautechnik* have to be used. The following fixings are specified there and are available in the colour matching the facade boards. In order to ensure the rivet is in the middle of the drill hole, the use of a step drill is recommended for drilling into the base structure (diameter: 5.1 mm). When positioning the rivet, a rivet jig / special gauge mouth-piece must be used.

- MBE facade rivet aluminium/niro 5.0 x 16 mm, bracketing range 7.0 - 10.5 mm, head diameter 14 mm
- MBE facade rivet aluminium/niro 5.0 x 18 mm, bracketing range 9.0 - 12.5 mm, head diameter 14 mm
- MBE facade rivet aluminium/niro 5.0 x 21 mm, bracketing range 12.0 - 15.5 mm, head diameter 14 mm



DESIGN OF FACADE BOARD FIXED AND SLIDING POINTS

Due to temperature changes and changes in humidity, the facade boards experience longitudinal changes (shrinkage and swelling), which results from the natural base material wood. The arrangement of sliding points ensures that there sufficient movement possibilities for the boards. Even large board formats up to 3640 x 1310 mm (effective size) can therefore be used.

Fixed point

The fixed point serves to absorb the vertical loads of the dead weight. To make the fixed point, a drill hole is made in the board with a diameter of 5.1 mm, which transfers the force from the board and fixing.

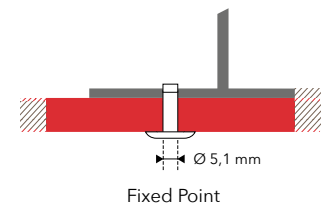

Sliding Point

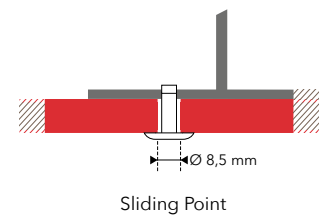

The fixing points are designed as sliding points serve to transfer horizontal loads (wind loads) and at the same time allow the required movement possibilities for the facade boards. The drill hole diameter of the sliding points is 8.5 mm.



Position of the fixed and sliding points

The fixed point is always positioned centrally so that movement is possible equally in all directions.

For narrow boards, which only need two rows of fixings in the vertical or horizontal direction, the fixed point is installed at the middle height of the board edge. The position of the fixed point or points within a facade area should always be chosen in the same position.

-  Fixed Point
-  Sliding Point

H = Horizontal fixing distance
 V = Vertical fixing distance
 G = Distance from edge to fixing
 $\geq 20 \text{ mm}$ and $\leq 10 \times$ board thickness

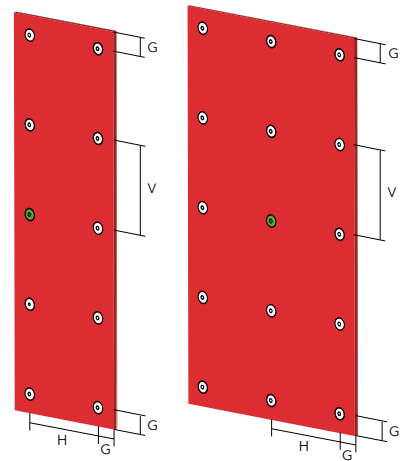

Arrangement of fixed and sliding points in a vertical base structure

Distance of fixings from the edge

The distances from the fixing (centre of the drill hole) to the edge of the board both horizontally and vertically must be at least 20 mm. The maximum distance from the edge must not exceed 10-times the board thickness.

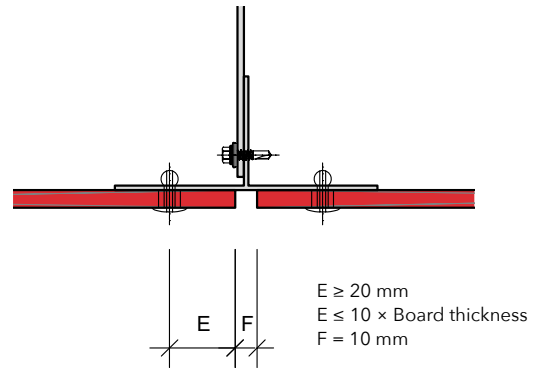

DISTANCES BETWEEN RIVET FIXINGS

For rear-ventilated external wall cladding, a property-related verification of stability must be prepared by an expert. To calculate the cut sizes, the storage conditions (supported rigidly or flexibly) have to be taken into account. The basis of the verification of stability is formed by the requirements of the National Technical Approval.

The maximum distance between fixings (H and V) of 600 mm for 6 mm, 700 mm for 8 mm and 800 for 10 and 12 mm boards must not be exceeded.

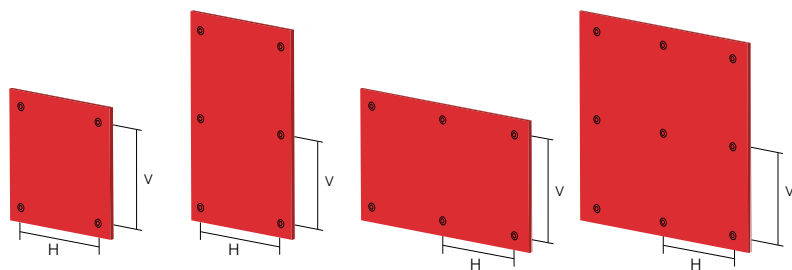

H = Horizontal fixing points
 V = Vertical fixing points

DETAILS OF THE METAL BASE STRUCTURE

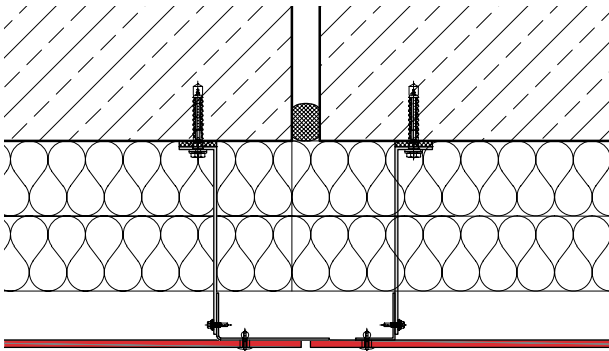

Expansion joint

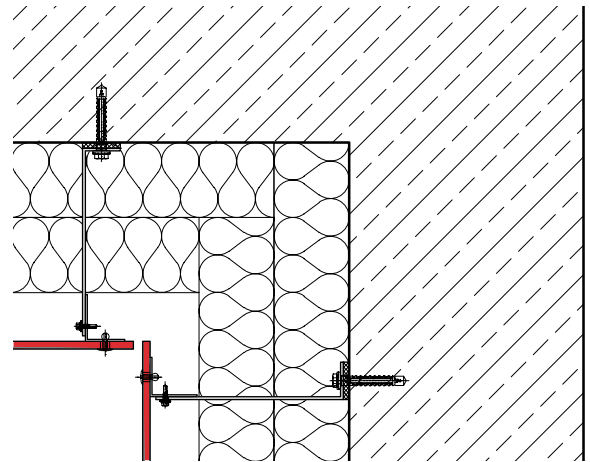

Internal corner

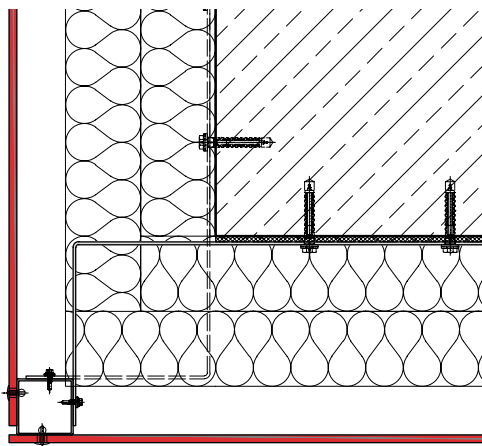

External corner

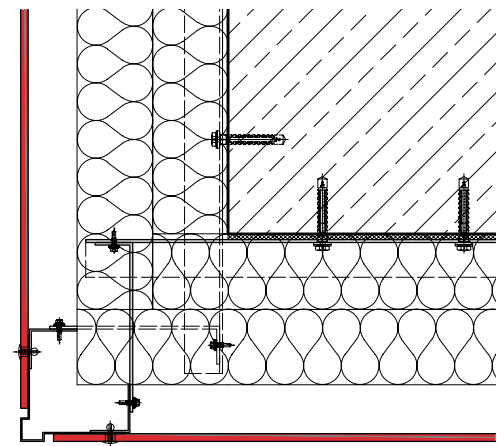

External corner with external corner profile

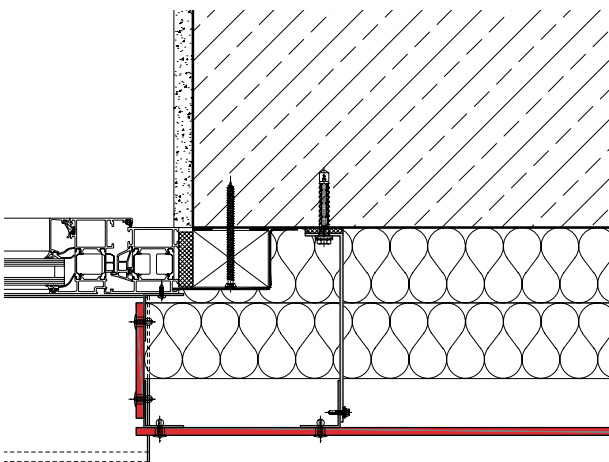

Window reveal with board material

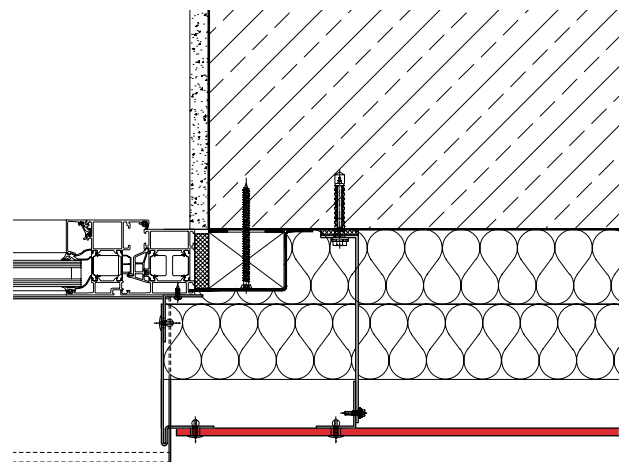

Window reveal with metal

DETAILS OF THE METAL BASE STRUCTURE

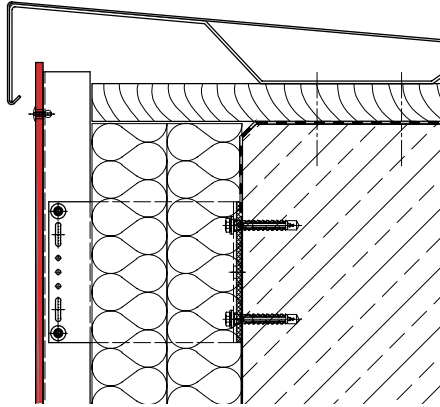

Attic connection

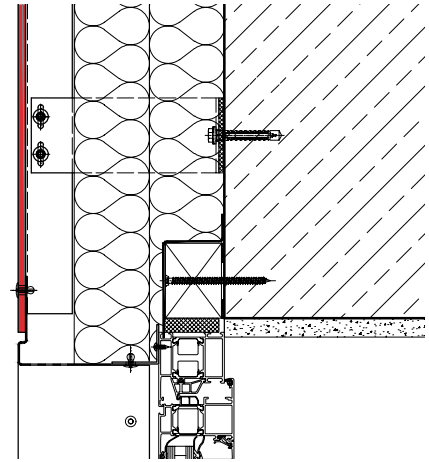

Lintel with metal

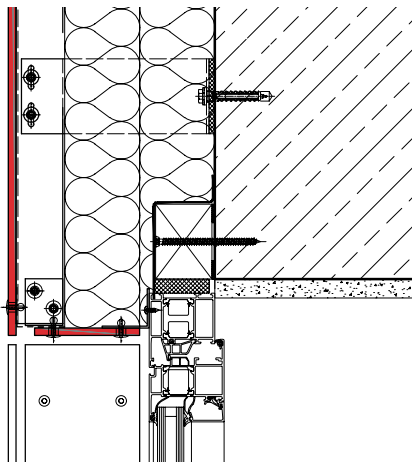

Lintel with board material

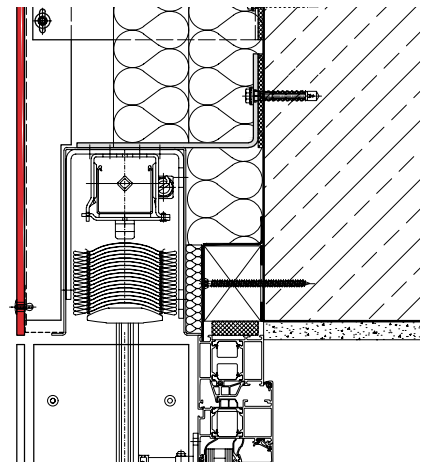

Lintel with Roman blinds

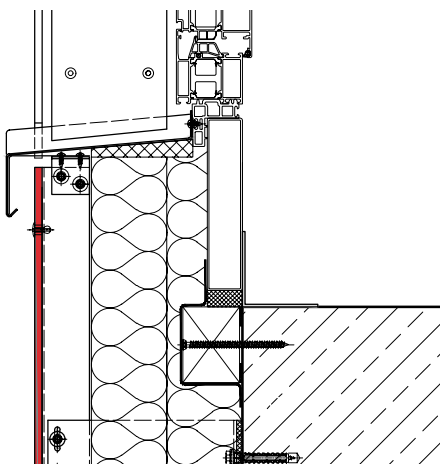

Window sill

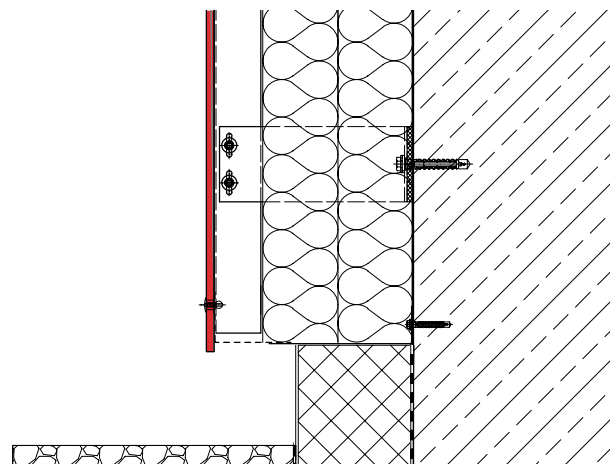

Base connection

V.

CONCEALED BONDED FIXING ON METAL BASE STRUCTURE

The assembly of RESOPLAN boards on aluminium base structures using bonding technology is a technically mature, economic solution that has been proven in practice, which allows more design freedom because visible fixings are not used, and which therefore generates higher value.

GENERAL INFORMATION

Suitable bonding systems for external application, and their National Technical Approval and European Technical Approval (ETA) are another possibility for concealed fixing of 8 mm, 10 mm and 12 mm RESOPLAN boards. This is achieved through a bonded connection between the facade boards and the base structure, which has to be made from aluminium.

Apart from compliance with the construction principles of the applicable standards, including "DIN 18516 External wall claddings, rear-ventilated", manufacturer-specific, precisely defined processing steps and material components guarantee the functioning and permanence of this fixing system.

As with all others, this fixing system also requires the following: Sufficiently large rear-ventilation cavity of at least 20 mm with a breath and ventilation cross-section of 50 cm²/m.

There are no restrictions with regards to format sizes for the design of the facade grid with RESOPLAN with bonded fixing.

The boards can be planned and machined up to the stated maximum effective sizes of all standard formats without restriction.

The maximum support distances (H) for the boards using vertical aluminium profiles are 700 mm for 8 mm boards and 800 mm for 10 and 12 mm boards, depending on the board thickness. They must not be exceeded, but as a result of the stability verification to be performed in the specific project may be smaller, however.

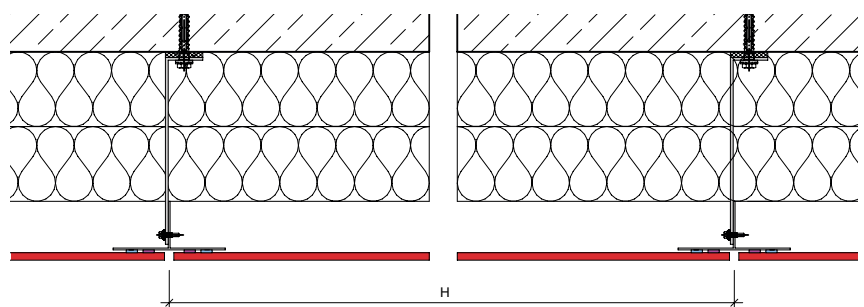

COMPONENTS OF THE BASE STRUCTURE

The aluminium base structure must correspond both to DIN EN 755-2 and to the requirements of the National Technical Approval or ETA from the respective manufacturer. Their components and assembly criteria are analogous to the chapter "Visible fixing on a metal base structure":

- **Support profile**, vertical or positioned so that no moisture remains in the area of the bonding and **wall mount**.

COMPONENTS OF THE BONDING FIXING

The following systems are tested and recommended for bonding RESOPLAN boards:

- MBE Panel loc (National Technical Approval Z-10.8-350)
- Sika Tack-Panel bonding system (National Technical Approval Z-10.8-408)

Both systems comprise the following, comparable components:

- Cleaner, primer (bonding agent), assembly tape and MS-polymer based adhesive (MBE) or single-component PUR elastomer (Sika)

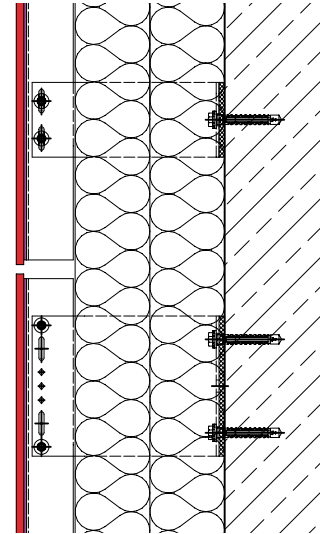

PROCESSING

The bonding systems can be processed both in the workshop and on the construction site. The bonding of the facade boards at the construction site may only be carried out by processors with corresponding proof of suitability. The processing instructions in the respective approvals / test certificates from the system providers must be observed here.

The bonding of RESOPLAN facade boards primarily comprise 3 steps, in which the respective system components are used:

- Pre-treatment of the base structure (polishing, cleaning, priming, ventilating)
- Pre-treatment of the RESOPLAN boards (polishing, cleaning, priming, ventilating)
- Bonding (application of assembly tape and adhesive, removal of the assembly tape film, alignment and adjustment of the RESOPLAN boards)

In principle, the following conditions must be complied with when bonding facade boards:

- Weather and dust-protected processing
- Air temperature must not be below +5°C and must not exceed +35°C
- The relative humidity must not exceed 75%
- The temperature during application and for four hours thereafter must not fall below +5°C
- The temperature of the components being bonded (UK, RESOPLAN boards) must be at least 3°C higher than the dew point temperature

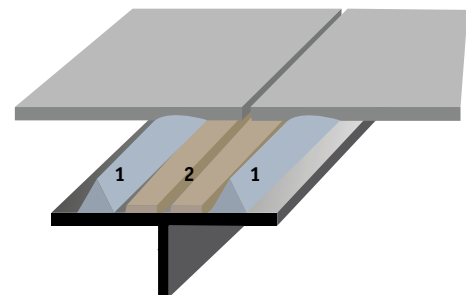

- 1 Applied adhesive
- 2 Adhesive tape

DETAILS OF BONDING ON A METAL BASE STRUCTURE

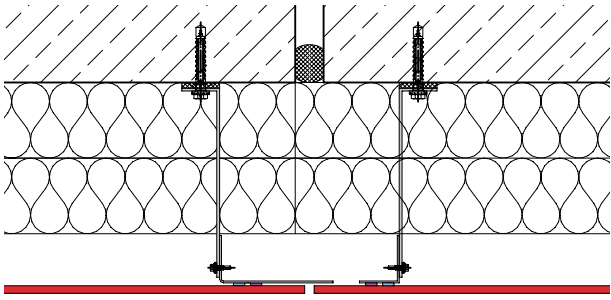

Expansion joint

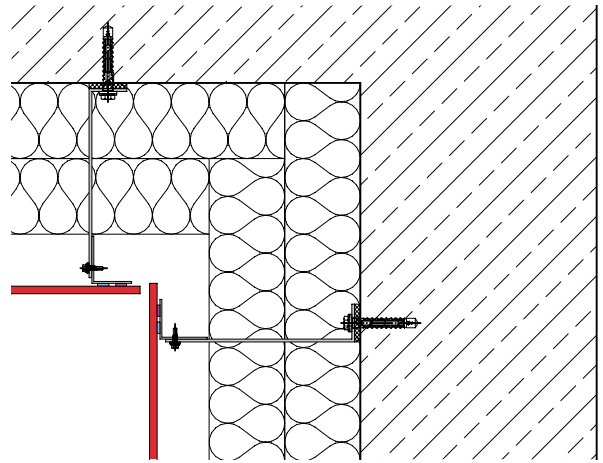

Internal corner

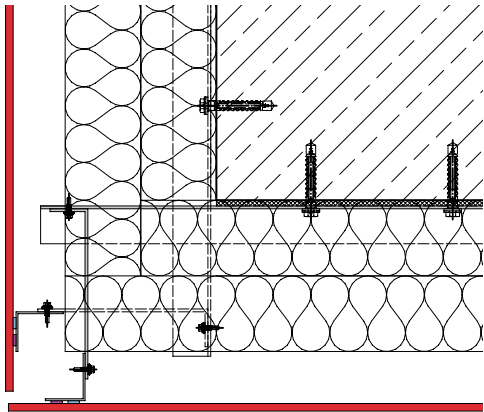

External corner

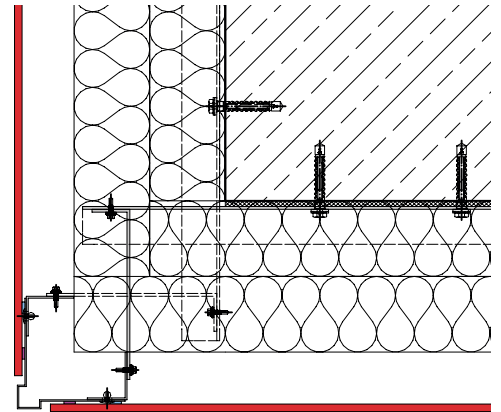

External corner with external corner profile

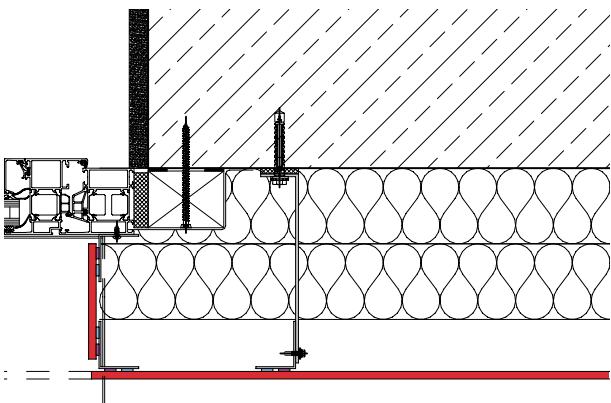

Window reveal with board material

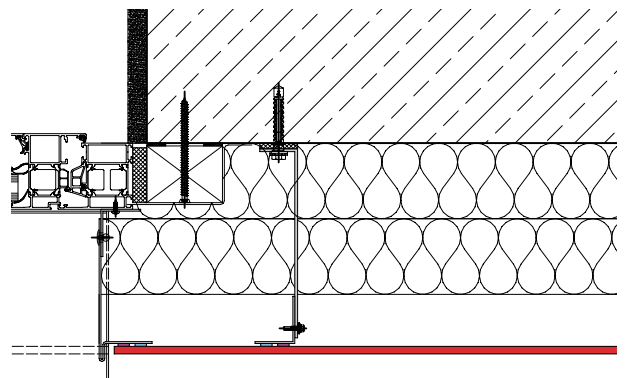

Window reveal with metal

DETAILS OF BONDING ON A METAL BASE STRUCTURE

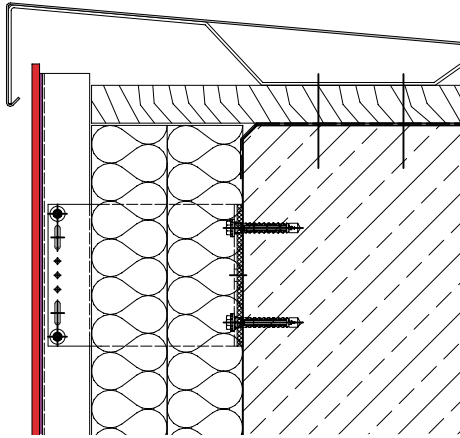

Attic connection

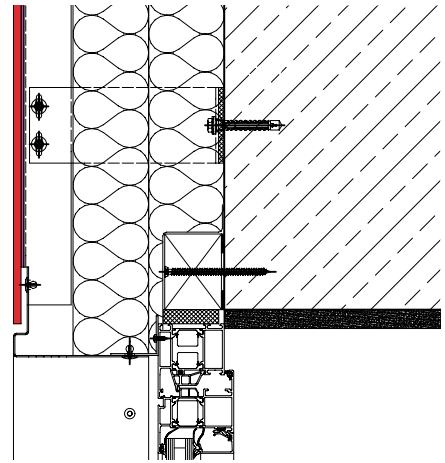

Lintel with metal

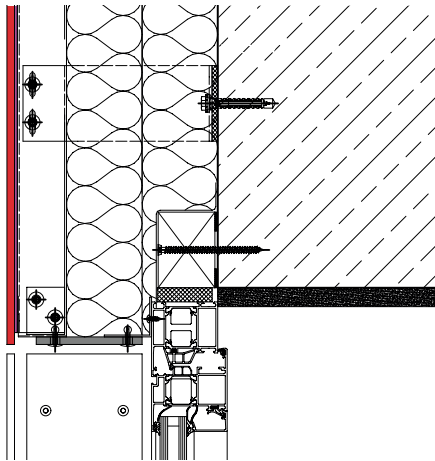

Lintel with board material

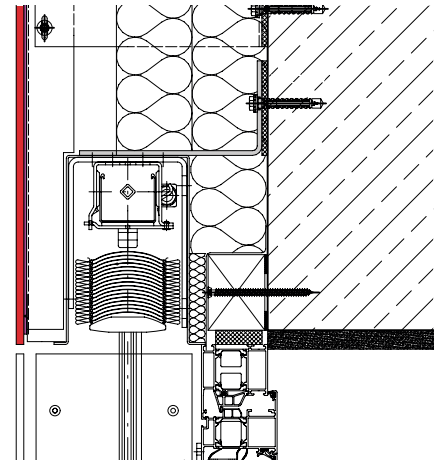

Lintel with Roman blinds

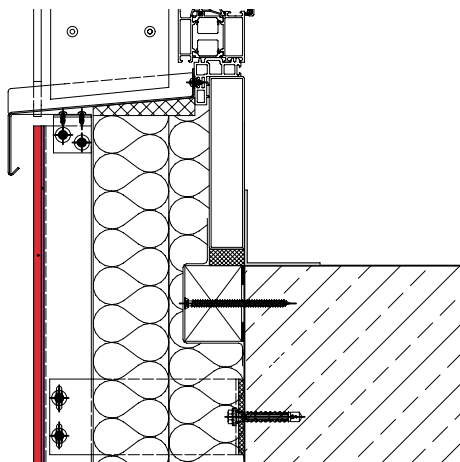

Window sill

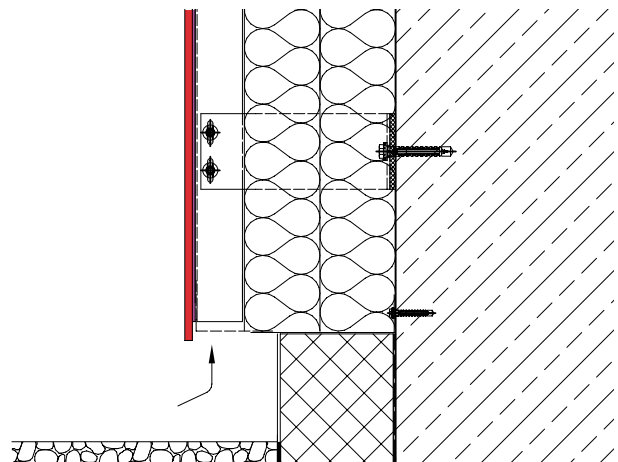

Base connection

VI.

CONCEALED MECHANICAL FIXING ON A METAL BASE STRUCTURE

The concealed (rear) fixing of RESOPLAN with a thickness of 8 mm, 10 mm and 12 mm on a metal base structure using a clasp system is a permanent, high-quality and attractive solution for new builds and renovations.

GENERAL INFORMATION

The rear fixing of RESOPLAN boards using a clasp system in conjunction with the TUF-S fixing system from SFS intec GmbH on a metal base structure is governed by ETA-+5/0476 for facade applications and thus offers maximum safety in the planning and installation of the facade.

In addition, complying with the structural principles of the applicable standards, including DIN 18156, Rear-ventilated external wall cladding, the functional safety and the longevity of the facade structure are guaranteed.

The sufficiently large free ventilation cavity of at least 20 mm with a breathing and ventilation cross-section of 50 cm²/m guarantees the functional safety of the facade structure. The maximum distance between fixings (H) (vertical and horizontal) 700 mm for 8 mm boards, 800 mm for 10 and 12 mm boards must not be exceeded.

With the TUF-S fixing system, perforated clasps are fixed to the rear of the facade boards. The facade boards fitted with clasps

are suspended in the matching horizontally-running support profiles and fixed at one point. The load transfer into the base structure can be through various base structures available on the market.

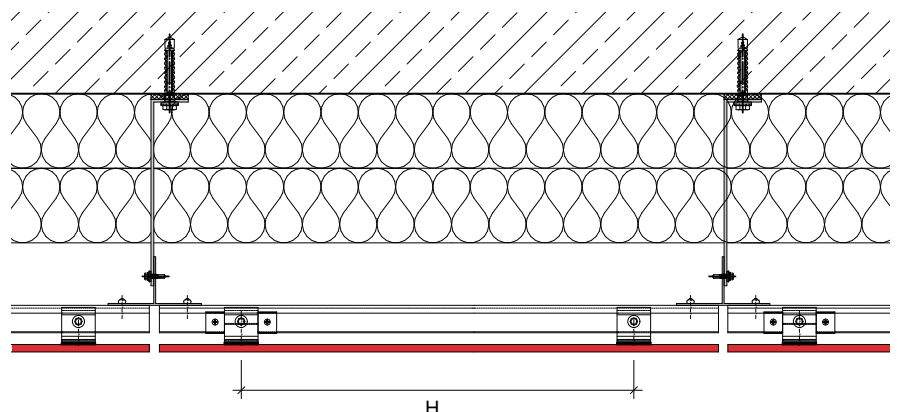

COMPONENTS OF THE BASE STRUCTURE

Clasp system

The base structure comprises a vertical basic structure, on which horizontal supporting profiles are mounted corresponding to the board grid.

At least two horizontal supporting profiles are needed for each facade board. Clasps are attached to the rear of the facade boards, which are suspended in the horizontal supporting profiles. The horizontal supporting profiles and the clasps must geometrically fit together. These components have to be purchased from the respective base structure manufacturer in the system. For aluminium horizontal supporting profiles, a minimum profile thickness of 2.0 mm must be selected. The minimum thickness of the clasps is 2.0 mm. To secure the position in the event of temperature and moisture-related movements of the suspended facade boards, a clasp is prevented from moving horizontally with a U-profile. The height of the board is adjusted using adjusting screws on two clasps in the upper row of clasps.

The clasps are fixed to the rear of the RESOPLAN boards with the TUF-S fixings from the SFS intec GmbH. To this end, the clasps have 6.5-7.0 mm diameter holes, into which the TUF-S fixing is inserted.

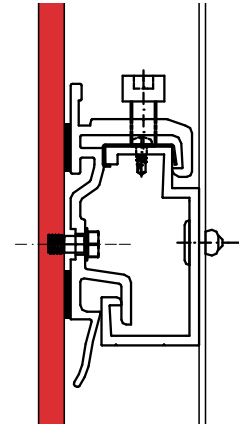

Vertical supporting profiles

With standard aluminium supporting profiles, a minimum thickness of 2.0 mm is required. T-profiles should have a width of at least 40 mm. For a joint between horizontal profiles, for example, a 100 mm-wide vertical supporting profile is fitted. A joint of approx. 15 mm is formed between the ends of the horizontal supporting profiles. This allows the expansion of the horizontal supporting profiles.

In order to prevent unwanted reflected light from the untreated UK profiles, black-coated supporting profiles can be used.

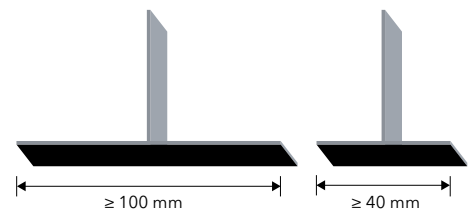

Wall mounts

When using aluminium wall mounts, a distinction is made between fixed and sliding points. The fixed points absorb vertical loads as well as horizontal loads from wind. The sliding point allows the unforced movement of the supporting profiles, which can occur due to temperature changes. To this end, the fixings are fixed in longitudinal holes. The movement possibility in the joints of the base structure also has to exist in the facade boards. Consequently, the facade boards must not be fitted across the movement joints of two supporting profiles.

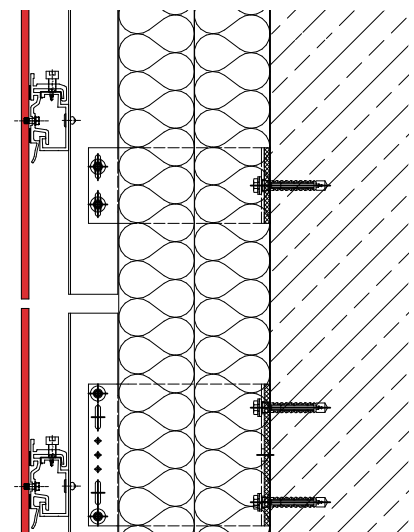

FIXING POINTS

Fixings

The concealed fixing of the RESOPLAN boards can be achieved with the TUF-S fixings from SFS intec GmbH, following ETA-15/0476. Depending on the board thickness (8 mm, 10 mm, 12 mm) and the thickness of the clasps used, different drill hole depths are required. It must be ensured that a remaining board thickness of 3 mm is observed. The minimum distance from the TUF-S fixing to the edge of the board is 40 mm. The maximum distance from the edge of 10-times the board thickness must not be exceeded. The minimum distance between fixings is 100 mm. If using double clasps, the minimum distance between groups of fixings is at least 100 mm.



TUF-S-6x XX-A4

FIXINGS AND DRILL HOLE DEPTHS

Fixing	Board thickness	Thickness of the clasp profile	Drill hole depth
TUF-S-6 × 7-A4	8 mm	2.0 mm	5.0 mm
TUF-S-6 × 8-A4	8 mm	3.0 mm	5.0 mm
TUF-S-6 × 9-A4	8 mm	4.0 mm	5.0 mm
	10 mm	2.0 mm	7.0 mm
	10 mm	2.5 mm	6.5 mm
TUF-S-6 × 10-A4	10 mm	3.0 mm	7.0 mm
	12 mm	4.0 mm	6.0 mm
		2.0 mm	8.0 mm
		2.5 mm	7.5 mm
TUF-S-6 × 11-A4	12 mm	3.0 mm	7.0 mm
		4.0 mm	6.0 mm
		2.0 mm	9.0 mm
		2.5 mm	8.5 mm
TUF-S-6 × 12-A4	12 mm	3.0 mm	8.0 mm
		4.0 mm	7.0 mm
		3.0 mm	9.0 mm
TUF-S-6 × 13-A4	12 mm	4.0 mm	8.0 mm

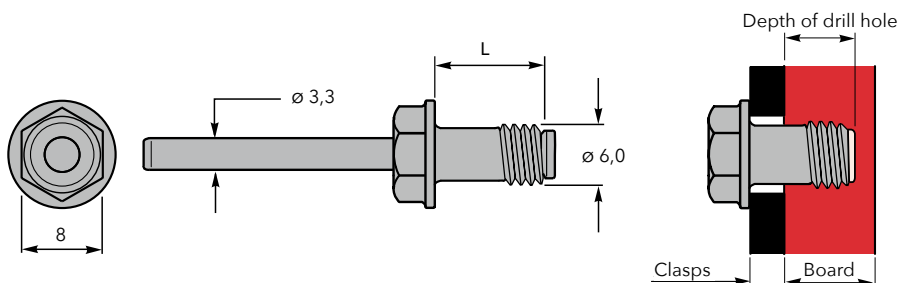

Dimensions of the TUF-S fixing

Making the drill holes

When making the drill holes on site, ensure that a drill /cutting tool with a rated diameter of 6.0 mm without a centring rod is used and the drill depth is taken into account.

If the blind holes are not prefabricated for the construction project, these can also be created on site with the special HSS blind hole drill from SFS intec GmbH and the accompanying depth stop. For blind holes drilled on site, the correct angle of the drill in respect of the facade board must be ensured.



HSS-6.0 x 40 to 43.5 drill bit with "Depth Locator" depth stop.

For the correction production of blind holes, drills with the "Depth Locator" depth stop as described in the ETA must be used. Drill bits HSS-6.0 x 40 mm to HSS-6.0 x 43.5 mm in 5-mm steps are available.

DRILL BIT AND DEPTH STOP

Designation	For hole depth
"Depth Locator" depth stop	
HSS-6,0 x 40	5.0 mm
HSS-6,0 x 40,5	5.5 mm
HSS-6,0 x 41	6.0 mm
HSS-6,0 x 41,5	6.5 mm
HSS-6,0 x 42	7.0 mm
HSS-6,0 x 42,5	7.5 mm
HSS-6,0 x 43	8.0 mm
HSS-6,0 x 43,5	8.5 mm

Clasp assembly

The quantity of clasps to be fixed to the back of the facade board is prescribed by the structural engineering and the assembly plan. The precise position of the drill holes is also shown in the assembly plan. After positioning the clasps and inserting the TUF-S fixing, its mandrel is completely removed with the GESIPA PowerBird® Pro riveting tool.



GESIPA PowerBird® Pro riveting tool

ASSEMBLY PROCEDURE



Drill the blind hole in the RESO-PLAN board with the HSS blind drill bit (diameter 6.00 mm) with depth stop. The depth stop ensures the precise drilling of the blind hole depth.

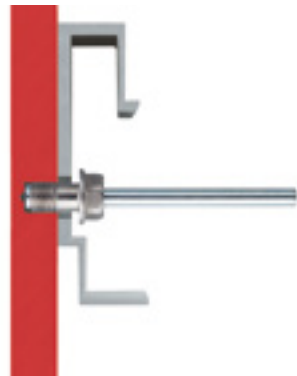

Position the pre-drilled clasps and insert the TUF-S fixing.

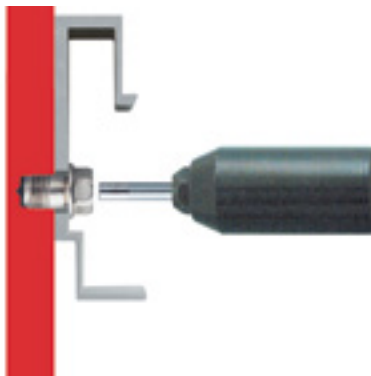



Remove the mandrel fully with the GESIPA PowerBird® Pro (use jaw 17/36 or 17/40).

Arrangement of the fixed and sliding points

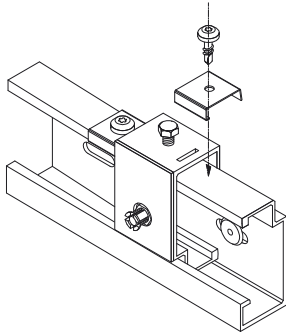
To secure the position in the event of temperature and moisture-related movements by the mounted facade board, the horizontal movement is prevented using a clasp made with U-profile sections. To this end, U-profile sections positioned on both sides of the clasps are solidly connected to the support profile. The movement of the other clasps is not hindered and this guarantees no-force positioning of the facade board.



-  Clasp with height adjustment screw as sliding point (the weight of the board is transferred to the UK with this clasp)
-  Clasp with height adjustment screw as fixed point (the weight of the board is transferred to the UK with this clasp)
-  Sliding point

H = Horizontal fixing distance
 V = Vertical fixing distance
 G = Distance from edge to fixing
 $\geq 40 \text{ mm}$ and $\leq 10 \times \text{board thickness}$

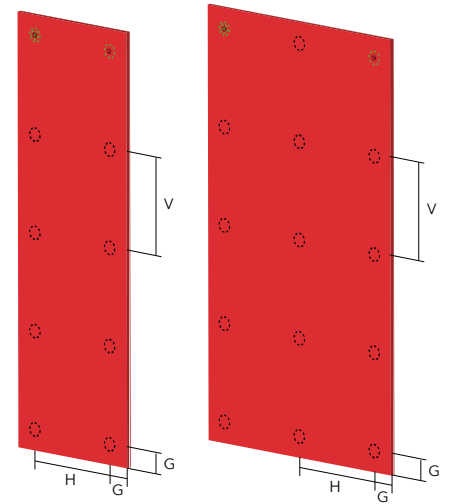

Distance of fixings from the edge

The distance from the TUF-S (middle of drill hole) to the edge, both horizontally and vertically, is at least 40 mm. The maximum edge distance must not exceed 10-times the board thickness.

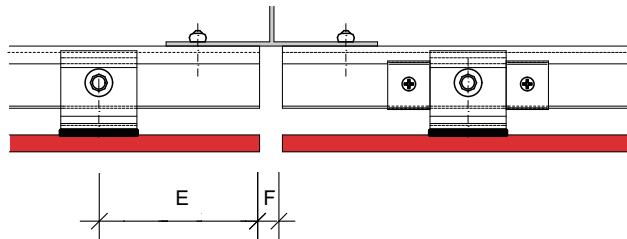

$E \geq 20 \text{ mm}$
 $E \leq 10 \times \text{Board thickness}$
 $F = 10 \text{ mm}$

DISTANCES BETWEEN FIXINGS FOR CONCEALED FIXING

For rear-ventilated external wall cladding, a property-related verification of stability must be prepared by an expert. To calculate the cut sizes, the storage conditions (supported rigidly or flexibly) have to be taken into account. The basis of the verification of stability is formed by the requirements of ETA-15/0476. The maximum distance between fixings (H and V) of 700 mm for 8 mm boards and 800 for 10 and 12 mm boards must not be exceeded. The minimum distance between fixings is 100 mm.

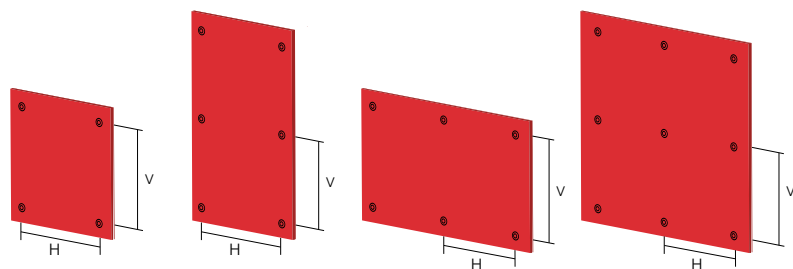

H = Horizontal fixing distance
 V = Vertical fixing distance

If the verification of stability for the transfer of loads requires a higher load-bearing capacity, a "double clasp" can be used instead of a "single clasp". The double clasp is a fixing group of two fixings with a centre distance of $20 \text{ mm} < a < 40 \text{ mm}$ or $40 \text{ mm} < a < 100 \text{ mm}$. If using double clasps, the minimum distance between fixing groups is at least 100 mm.

DETAILS OF THE CONCEALED FIXING ON METAL BASE STRUCTURE

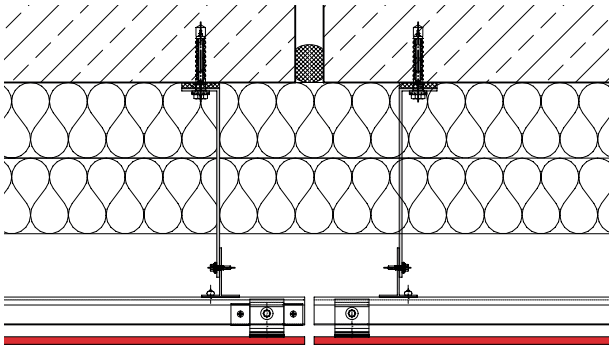

Expansion joint

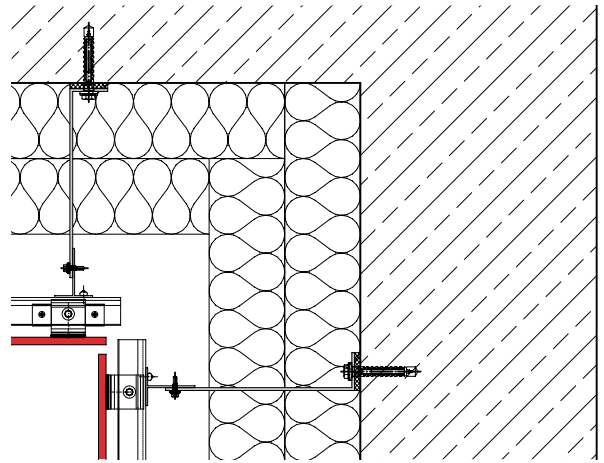

Internal corner

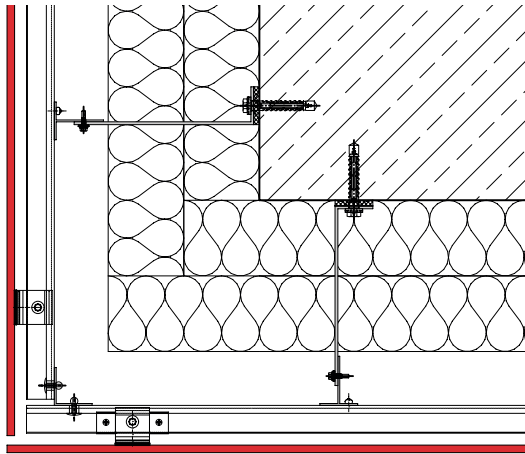

External corner

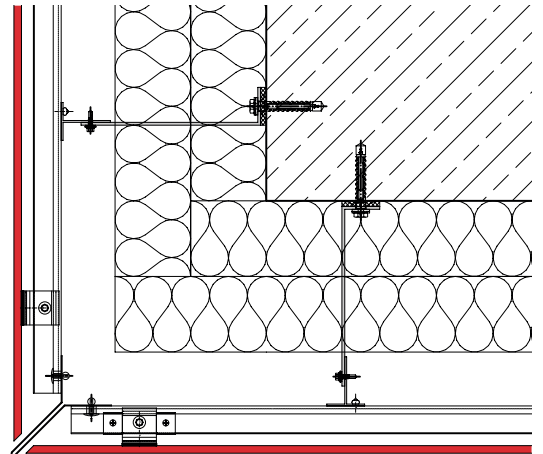

External corner with centre board

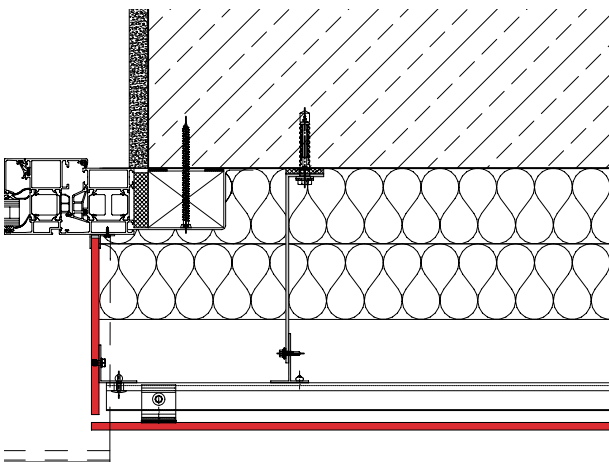

Window reveal with board material

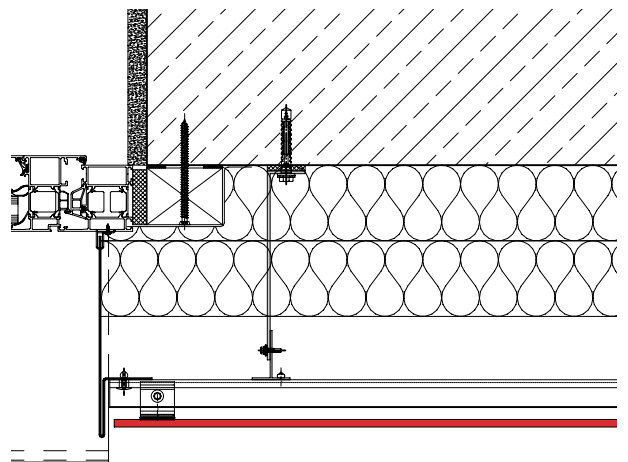

Window reveal with metal

DETAILS OF THE CONCEALED FIXING ON METAL BASE STRUCTURE

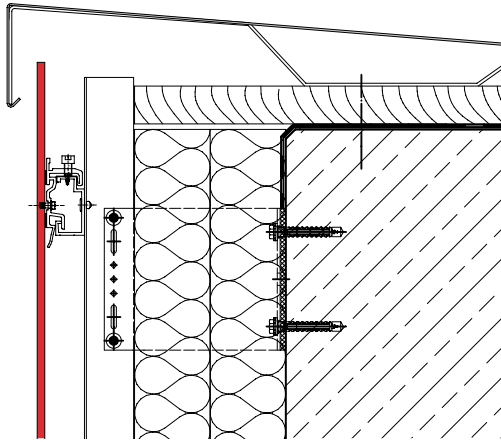

Attic connection

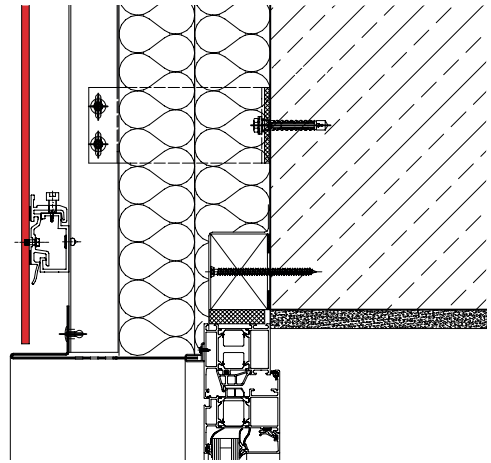

Lintel with metal

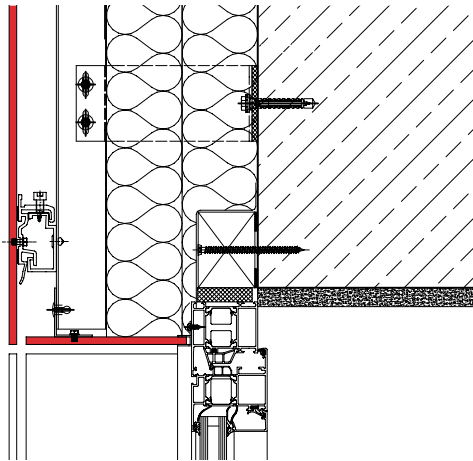

Lintel with board material

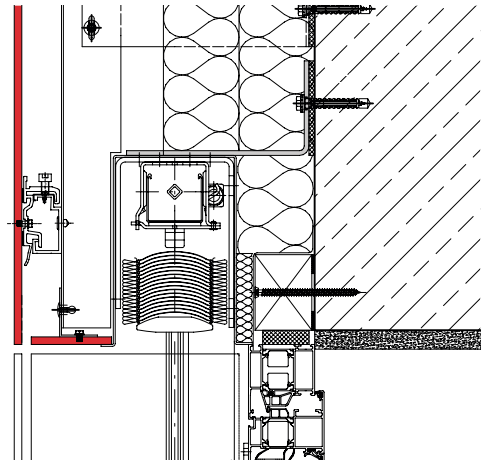

Lintel with Roman blinds

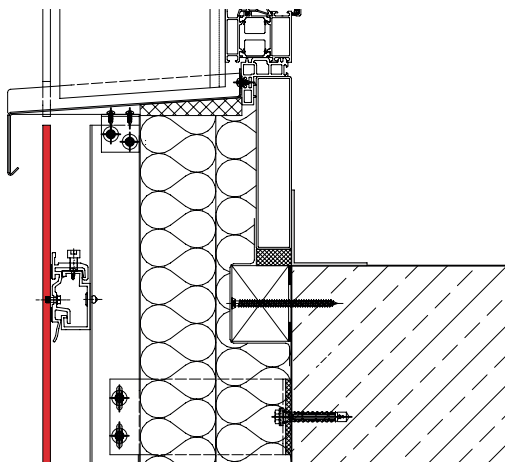

Window sill

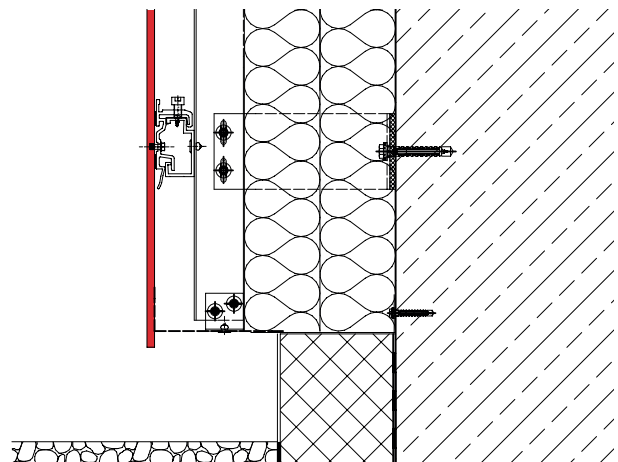

Base connection

VII.

VISIBLE FIXING ON WOODEN BASE STRUCTURE

To fix RESOPLAN to a wooden base structure, facade screws are used, which are available in a large number of colours to match the colour of the facade boards. This type of facade construction is easy to install, economical and long-lasting. It is used in many different types of building.

GENERAL INFORMATION

In accordance with the National Technical Approval and other applicable provisions, a stable and technically and visually high-quality facade is created.

The sufficiently large free ventilation cavity of at least 20 mm with a breathing and ventilation cross-section of 50 cm²/m guarantees the functional safety of the facade structure. The maximum distance between fixings (H) of 600 mm for 6 mm boards, 700 mm for 8 mm and 800 mm for 10 and 12 mm boards must not be exceeded.

The facade boards are fixed to vertically running supporting profiles, which are protected with an EPDM joint tape. The vertical supporting panels can be fixed to the anchoring base with wall mounts, frame plugs or laminated wood base structures. If there are no further requirements regarding thermal insulation for the external wall, e.g. for wooden frame construction, in which the insulation plane is between the supporting struts, a single-layered, vertically running

support battens can be sufficient.

According to DIN 68800-2 Wood preservation, preventive structural measures protect wooden base structures. When complying with the requirements of use class (GK) 0, the supporting and counter battens are not chemically treated against mould and insect infestation.

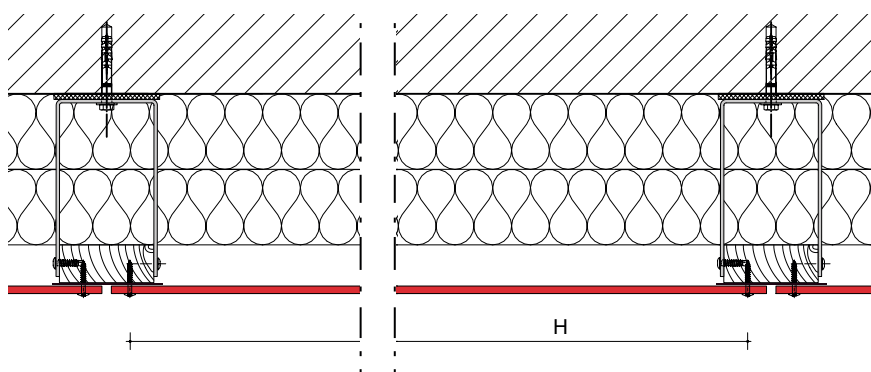

COMPONENTS OF THE BASE STRUCTURE

Supporting profiles

The softwood supporting batten must at least correspond to grading class S10 according to DIN 4074-1 or minimum strength class C24 EN 338. The minimum sizes based on the minimum edge distances for facade screws in wood. For battens on the board joint, they also depend on the joint width and the minimum edge distances for the board screws at the edge of boards.

Supporting batten in the field of the facade board:

- Base structure not pre-drilled: $W \times D = 60 \times 40$ mm

Supporting batten at the board joint:

- Base structure not pre-drilled: $W \times D = 120 \times 40$ mm

The battens must be protected against moisture with EPDM joint tapes. The joint tape must extend beyond the batten on both sides by 5 mm.

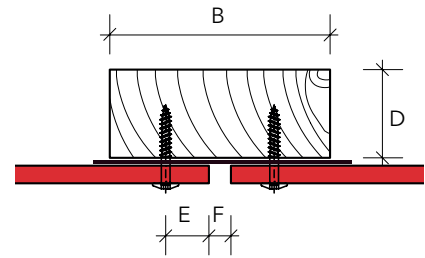
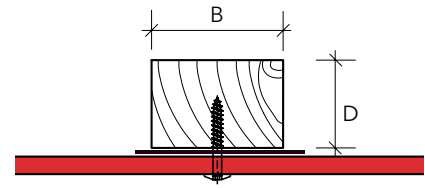

$E \geq 20$ mm
 $E \leq 10 \times \text{Board thickness}$
 $F = 10$ mm

Construction

The transfer of loads from the batten to the wall base structure can be by, for example, horizontal and vertical counter battens, frame plugs or wall mounts. When selecting the connectors, the corresponding standards and approvals must be observed.



Structure with horizontal counter battens

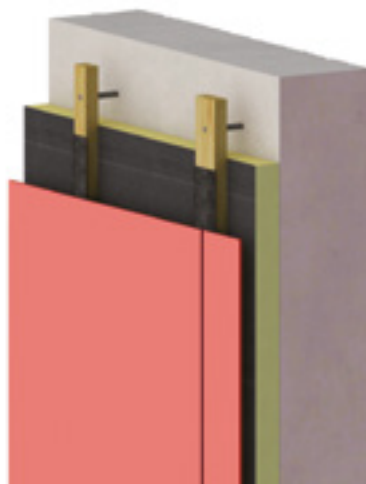

Structure with frame plugs

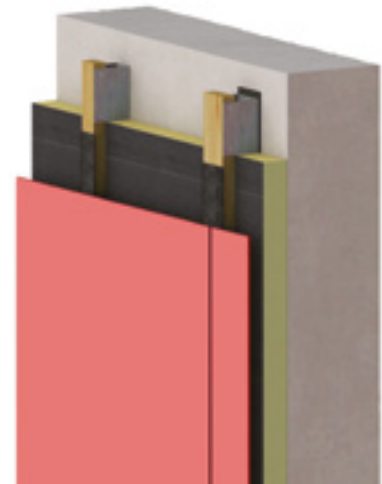

Structure with wall mounts

FIXING POINTS

Fixings

The fixings described in the National Technical Approval must be used. The following fixings are stated there and are available in the colour matching the facade boards. They can be used for board thicknesses of 6 to 12 mm.

- MBE facade screw 5.5 x 35 mm, head diameter 12 mm



DESIGN OF FACADE BOARD FIXED AND SLIDING POINTS

Due to temperature changes and changes in humidity, the facade boards experience longitudinal changes (shrinkage and swelling), which results from the natural base material wood. The arrangement of sliding points ensures that there sufficient movement possibilities for the boards. Even large board formats up to 3640 x 1310 mm (effective size) can therefore be used.

Fixed point

The fixed point serves to absorb the vertical loads of the dead weight. To make the fixed point, a drill hole is made in the board with a diameter corresponding to the fixing. For a 5.5 mm screw, a hole of 5.6 mm is drilled.

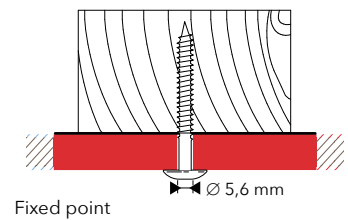

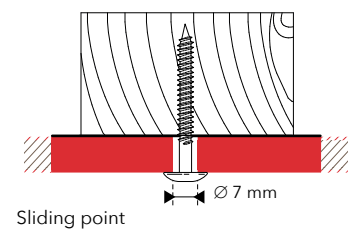

Sliding point

The fixing points that are designed as sliding points serve to transfer horizontal loads (wind loads) and at the same time allow the required movement possibilities for the facade boards. The drill hole diameter of the sliding points is 7 mm.



Position of the fixed and sliding points

The fixed point is always positioned centrally so that movement is possible equally in all directions. For narrow boards, which only need two rows of fixings in the vertical or horizontal direction, the fixed point is installed at the middle height of the board edge. The position of the fixed point or points within a facade area should always be selected in the same position.

-  Fixed point
-  Sliding point

H = Horizontal fixing distance
 V = Vertical fixing distance
 G = Distance from edge to fixing
 $\geq 20 \text{ mm}$ and $\leq 10 \times \text{board thickness}$

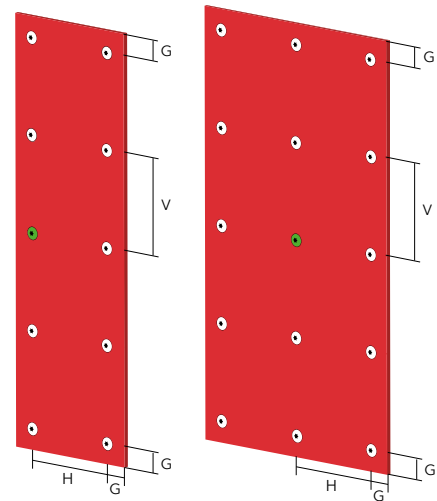

Arrangement of fixed and sliding points in a vertical base structure

Distance of fixings from the edge

The distances from the fixing (centre of the drill hole) to the edge of the board both horizontally and vertically must be at least 20 mm. The maximum distance from the edge must not exceed 10-times the board thickness.

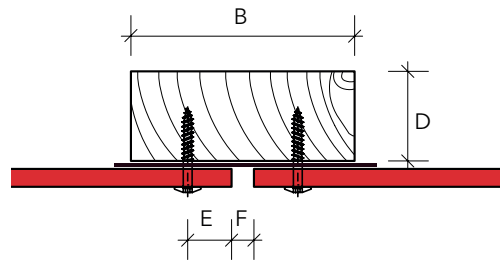

$E \geq 20 \text{ mm}$
 $E \leq 10 \times \text{Board thickness}$
 $F = 10 \text{ mm}$

DISTANCES BETWEEN SCREW FIXINGS

For rear-ventilated external wall cladding, a property-related verification of stability must be prepared by an expert. To calculate the cut sizes, the storage conditions (supported rigidly or flexibly) have to be taken into account. The basis of the verification of stability is formed by the requirements of the National Technical Approval.

The maximum distance between fixings of 600 mm for 6 mm, 700 mm for 8 mm and 800 mm for 10 and 12 mm boards must not be exceeded.

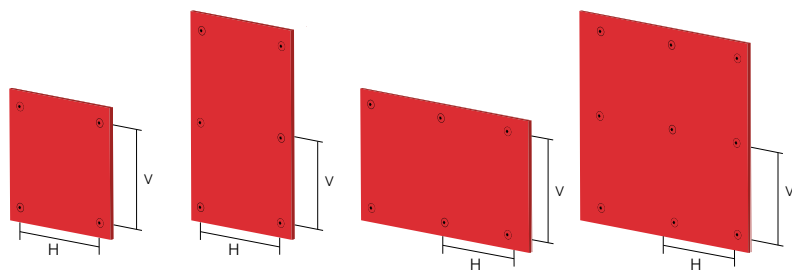

H = Horizontal fixing distance
 V = Vertical fixing distance

DETAILS OF WOODEN BASE STRUCTURE

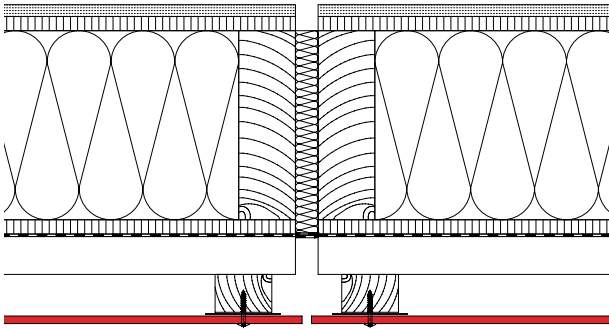

Expansion joint

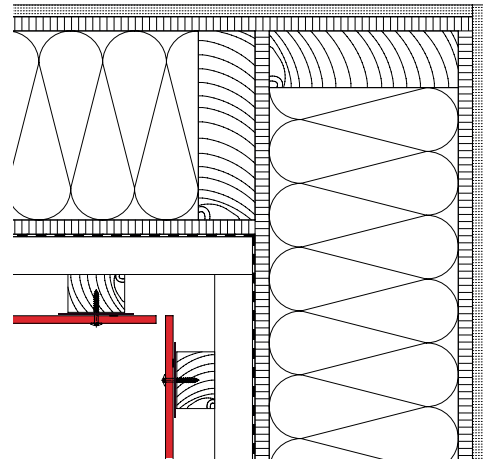

Internal corner

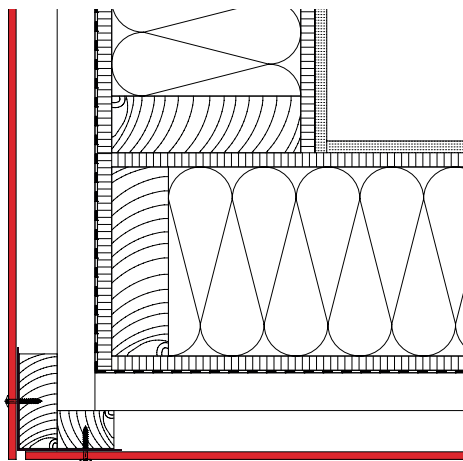

External corner

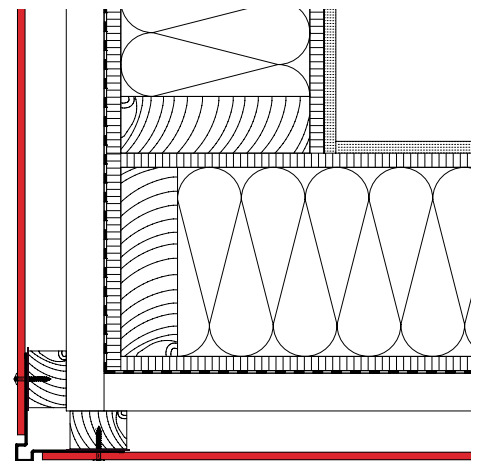

External corner with external corner profile

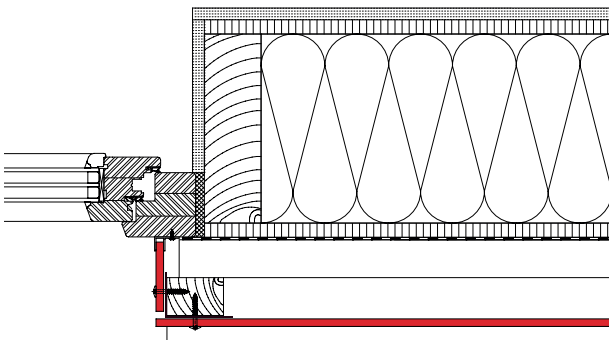

Window reveal with board material

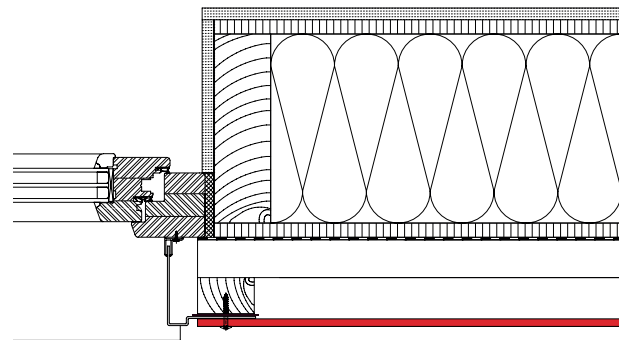

Window reveal with metal

DETAILS OF WOODEN BASE STRUCTURE

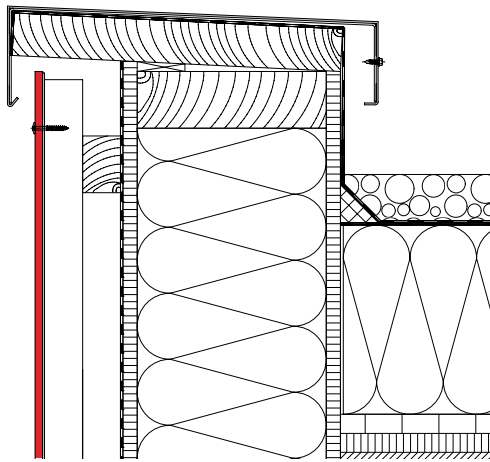

Attic connection

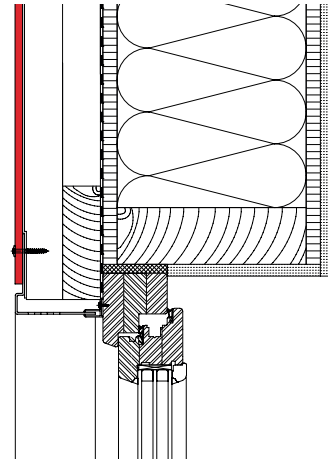

Lintel with metal

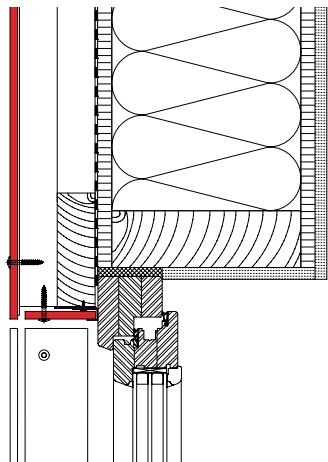

Lintel with board material

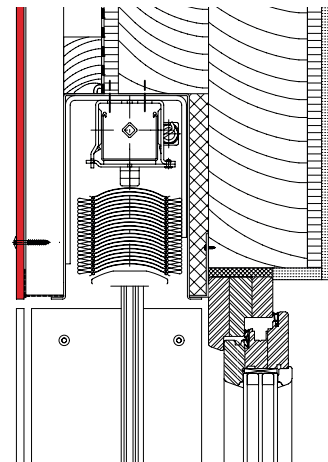

Lintel with Roman blinds

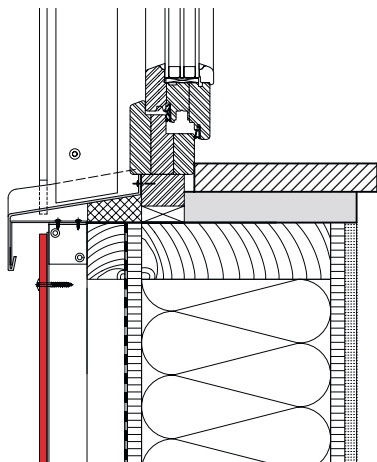

Window sill

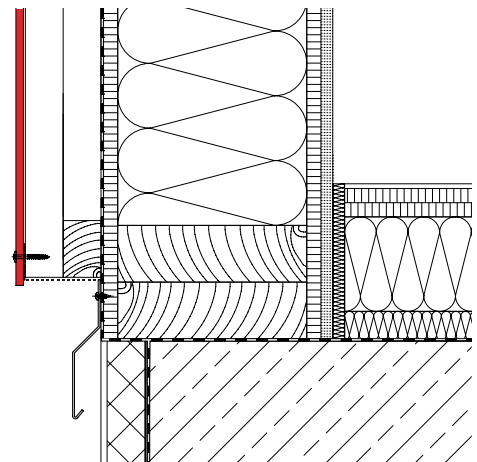

Base connection



VIII.

CONCEALED FIXING ON WOODEN BASE STRUCTURE

Clapboard is a panel-like external cladding with panel width of ≤ 300 mm and a distance between supports of ≤ 600 mm. It gives the facade's appearance structure and depth.

For clapboard cladding, the RESOPLAN boards, which are cut into panels, are fitted overlapping. The fixings are concealed in the overlapping area of the panels. Brackets can be used as fixings, which grip into the grooves on the underside of the panels. Alternatively, screws can also be used.

GENERAL INFORMATION

For clapboard cladding, at least 8 mm thick RESOPLAN boards are cut into strip-like panels. The length of the panels should not exceed 3650 mm.

The clapboard is fitted on vertical supporting profiles, traditionally made from wood, with a maximum distance of 600 mm. The requirements in respect of the rear ventilation of the facade, the use of joint tape and wood preservative apply to the same extent as when installing large-format facade boards.

The panel joints can be vertically over each other (vertical lattice) or offset (e.g. wild or half lattice).

In order to ensure a consistent look, it is necessary to realise the same angle for the panels at the lower edge of the cladding and over recesses - such as windows. To this end, a narrow strip of board is fitted at the start of the wall beneath the first panel.

Building corners can be created using profiles in colours matching the cladding, which are available in specialist retailers. In addition, solutions based on cut panels are also possible.



FIXING WITH SCREWS

When using screws as fixings, the facade panels have a maximum height of 200 mm. The panels should overlap by at least 30 mm.

Facade screws are used as fixings, which are also used when fitting flat. Head-painted screws can be used in the uppermost row of fixings for aesthetic reasons.

- MBE facade screw 5.5 x 35 mm for board thicknesses of 8 to 12 mm

The facade screws are screwed in at 90° to the panel without forcing the panel. The distance from the screws to the edge of the panel is at least 20 mm. When fitting clapboard, a fixed point is positioned in the middle of the panel and a minimum sufficient movement possibility is realised with sliding points at the other fixing points.

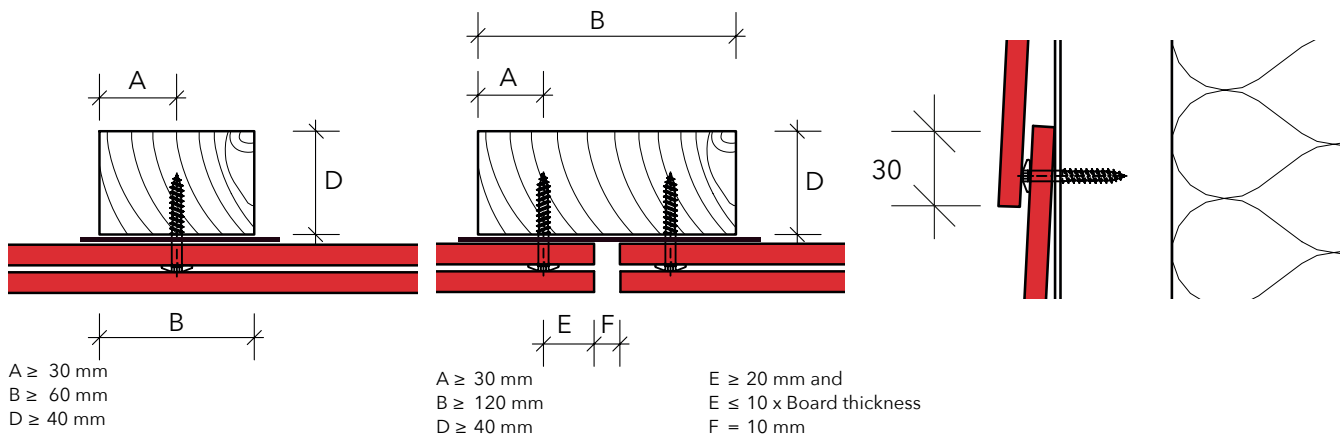

FIXING WITH BRACKETS

When fixing with brackets, the panels milled on the underside are placed in the fixing bracket, thereby being secured in place. The brackets are screwed to the vertically running supporting battens and hold the upper side of the panel. The uppermost panel is fixed with coloured facade screws. The panels overlap by approx. 25 mm. The maximum height of the panels when fixing with brackets is 300 mm. For vertical joints, it is necessary to fist both ends of the panel with one bracket each. The middle of each panel should be fixed with a screw in order to prevent the panels moving.

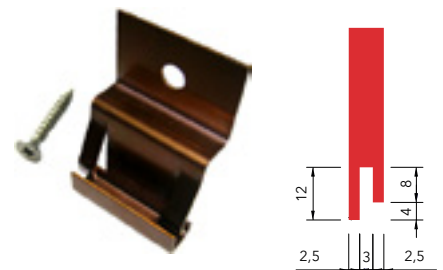
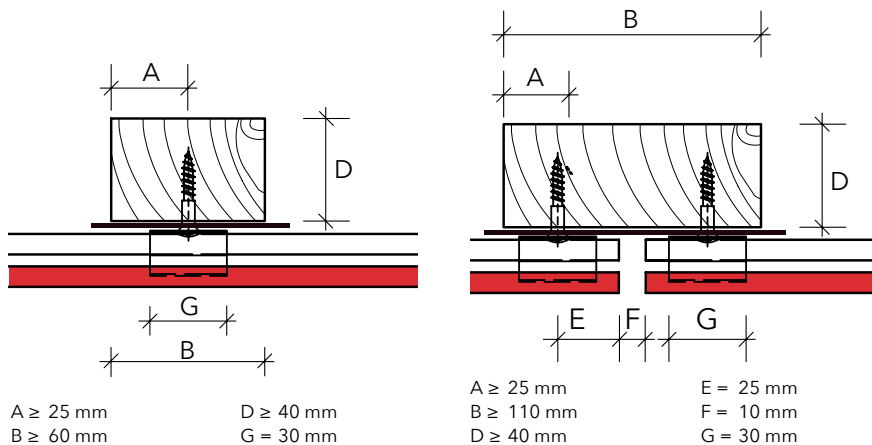

Bracket: MBE
 Material: Stainless steel 1.4310 - inox 301/2
 Dimensions: 30 x 45 x 0.8 mm
 Hole diameter: 5.5 mm
 For board thickness > 8 mm, the geometry of the brackets must be adjusted.

Screw for fixing the bracket:
 Type: Countersunk head
 Material: Stainless steel A2
 Dimensions: 4.5 x 30 mm
 Head: Torx or crosshead

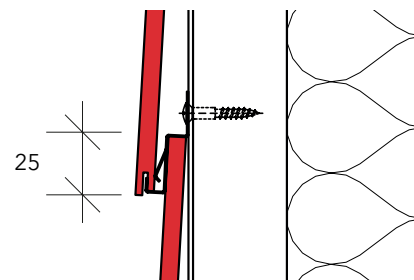

DETAILS OF CLAPBOARD FIXING WITH SCREWS

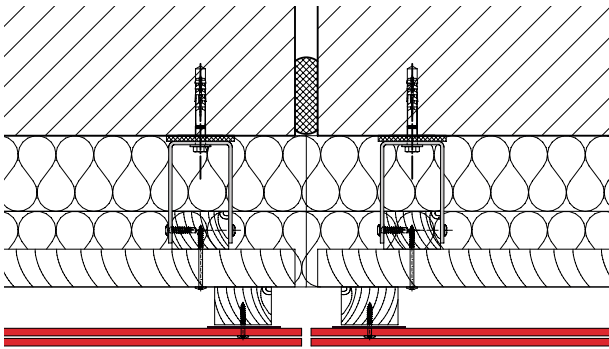

Expansion joint

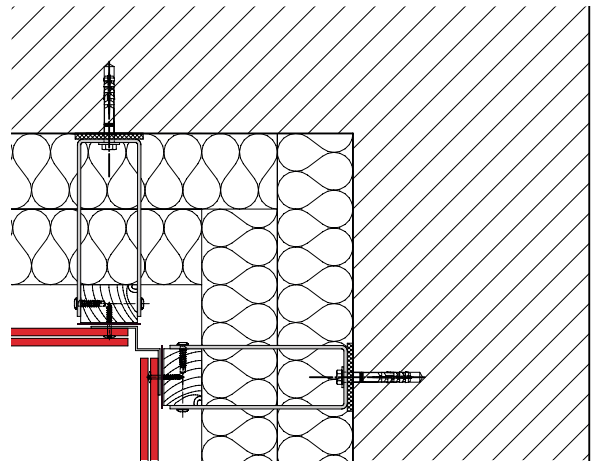

Internal corner

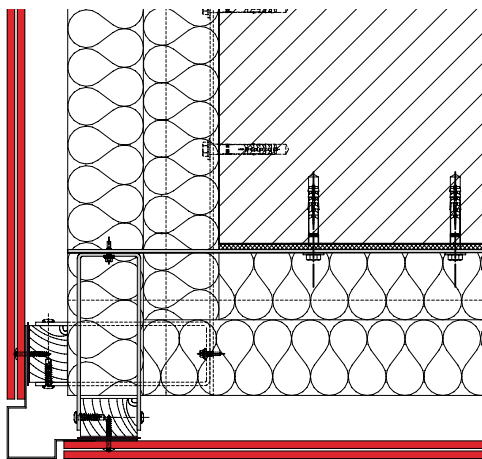

External corner

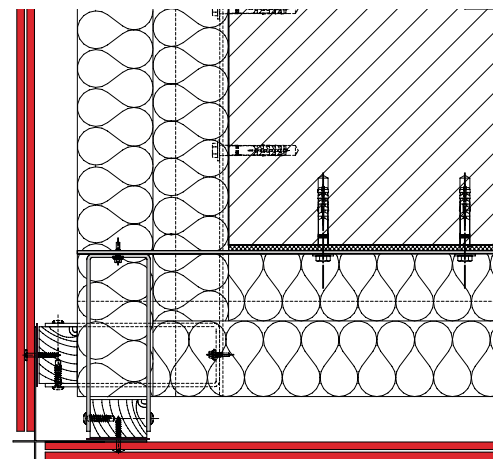

External corner with external corner

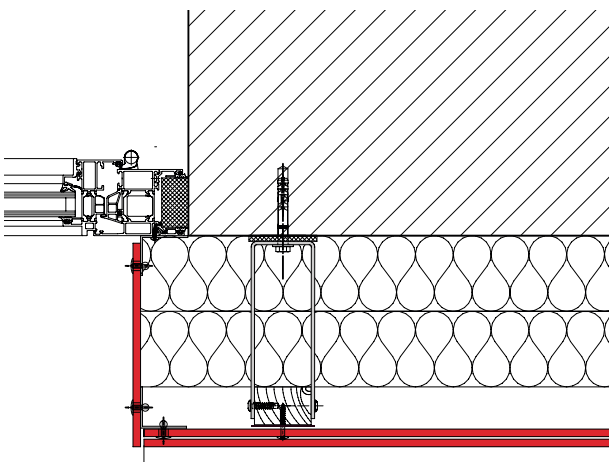

Window reveal with board material

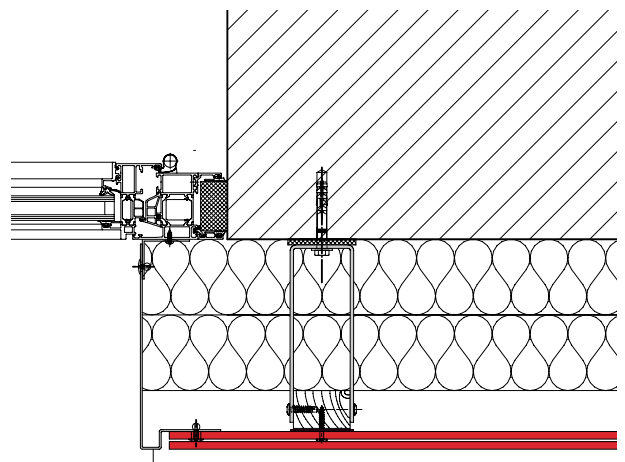

Window reveal with metal

DETAILS OF CLAPBOARD FIXING WITH SCREWS

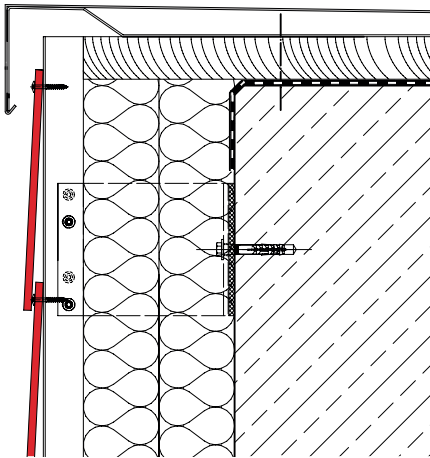

Attic connection

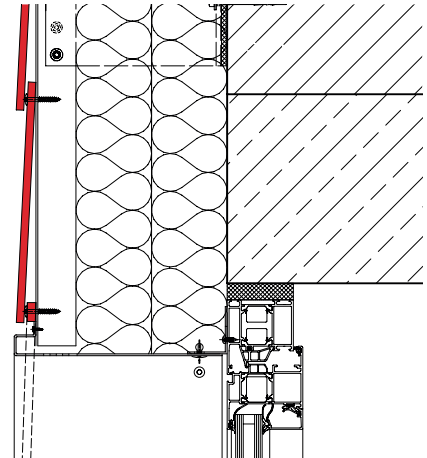

Lintel with metal

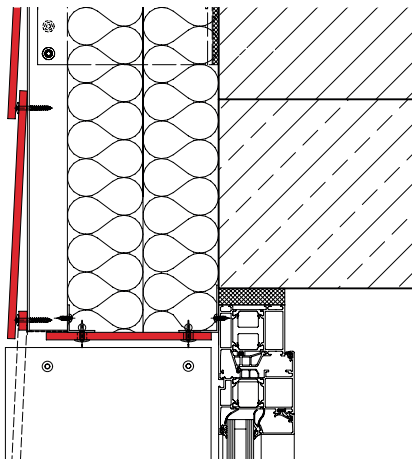

Lintel with board material

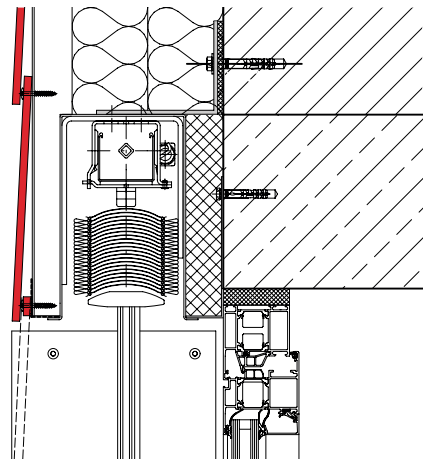

Lintel with Roman blinds

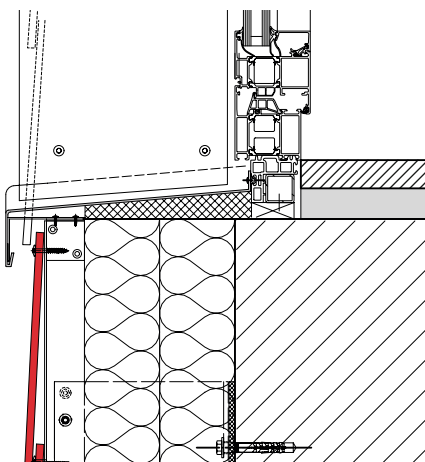

Window sill

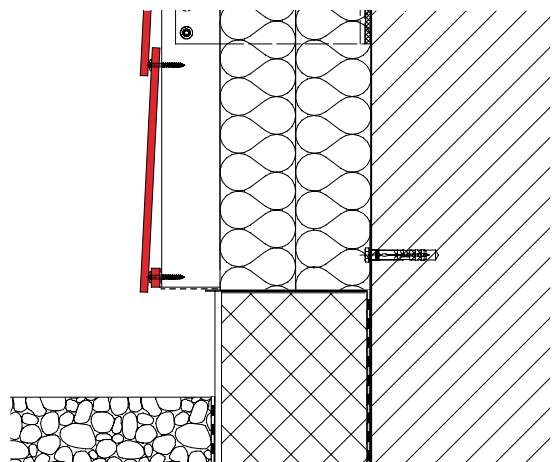

Base connection

DETAILS OF CLAPBOARD FIXING WITH BRACKETS

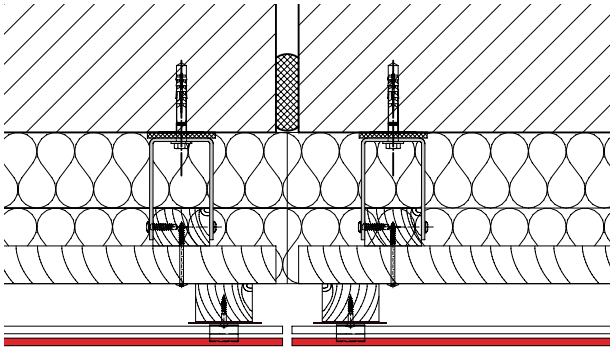

Expansion joint

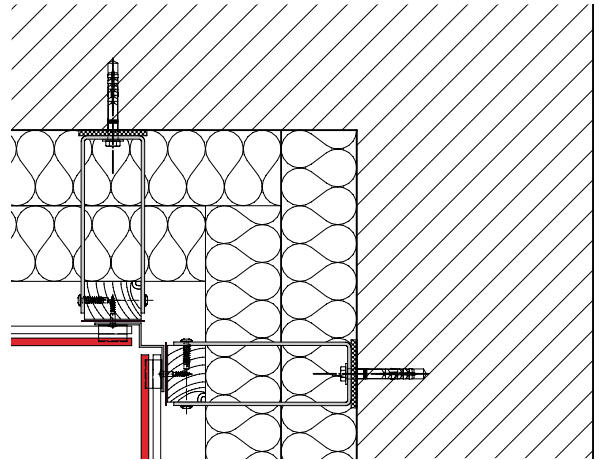

Internal corner

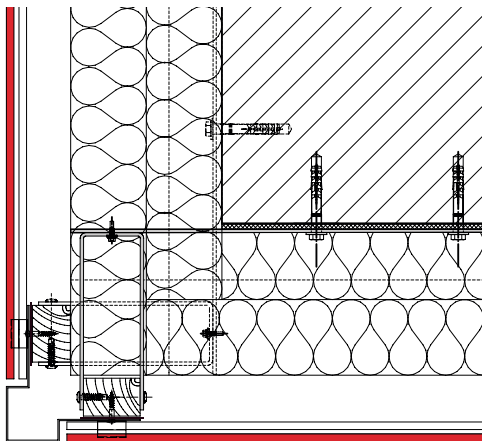

External corner

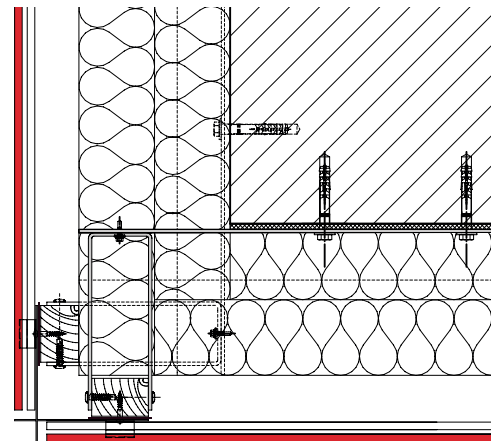

External corner with external corner

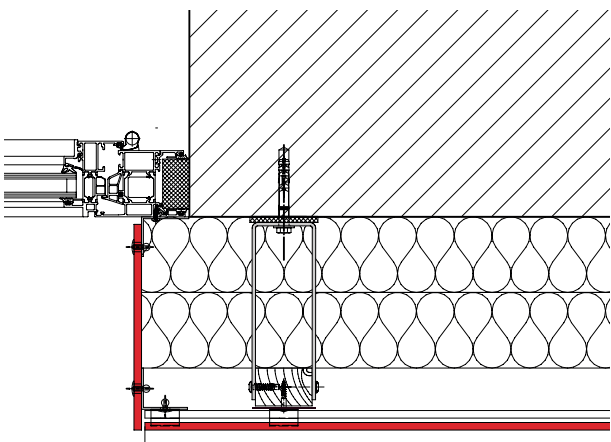

Window reveal with board material

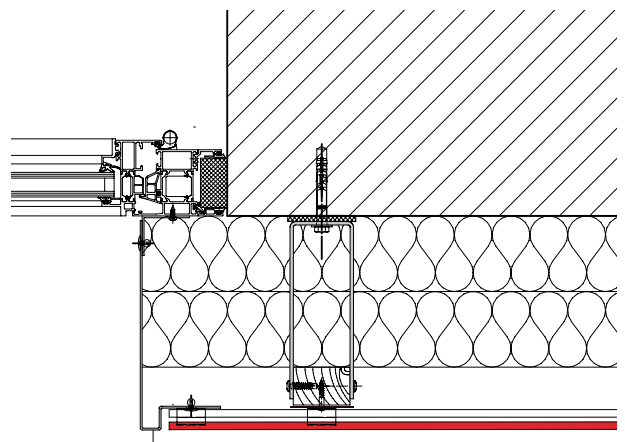

Window reveal with metal

DETAILS OF CLAPBOARD FIXING WITH BRACKETS

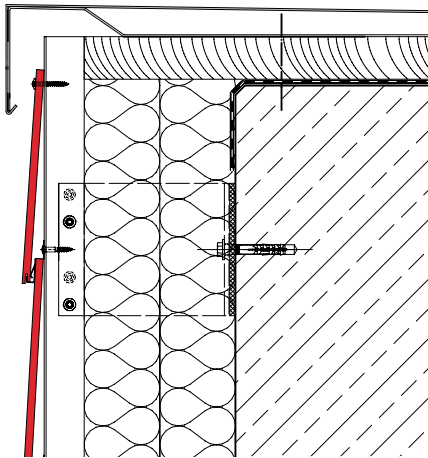

Attic connection

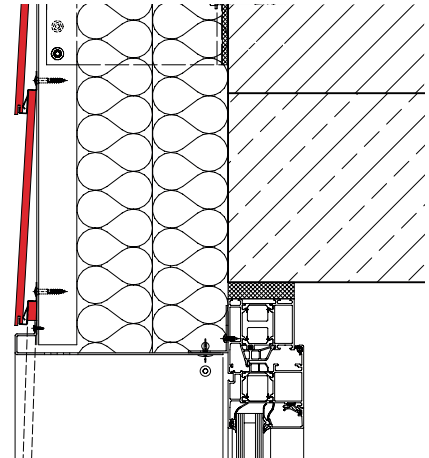

Lintel with metal

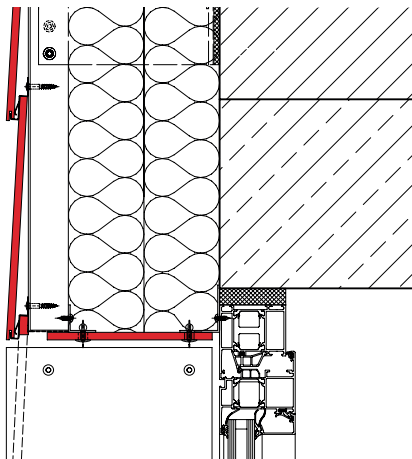

Lintel with board material

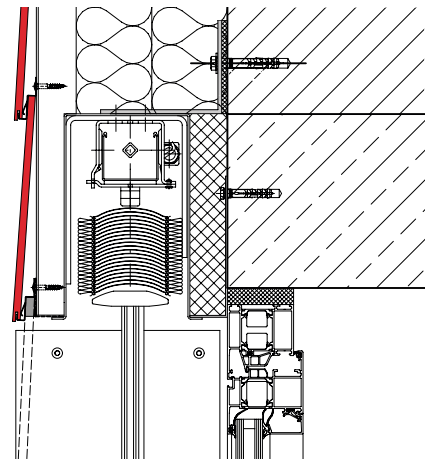

Lintel with Roman blinds

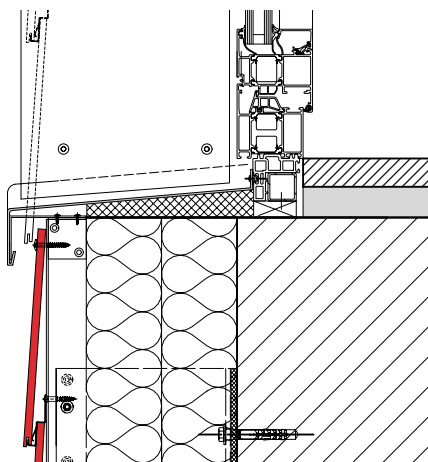

Window sill

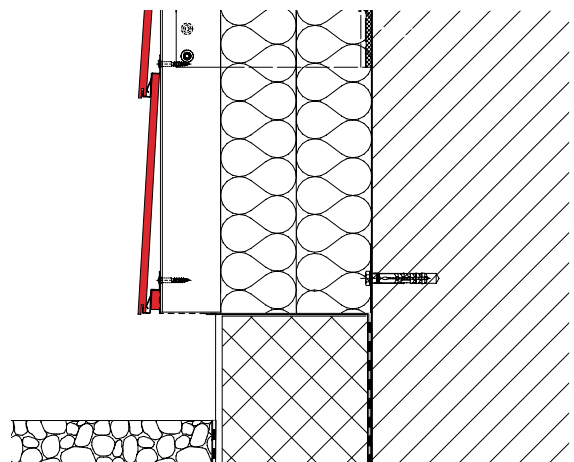

Base connection



IX.

MATERIAL COMBINATIONS

One feature is the combination of traditional fascia or rendered facades and thermal insulation composite systems with rear-ventilated facades. RESOPLAN is excellently suited for this. Because of the large format, colour and decorative selection, buildings can be given particular accents. The combination of contrasting materials gives buildings an individual character.

GENERAL INFORMATION

The technical realisation of the connections between the different materials can be realised securely and permanently with little effort. It must be ensured, however, that the different material behaviours are taken into account in structural terms (e.g. expansion behaviour), for example by installing joints between the different materials.

DO YOU HAVE ANY QUESTIONS?

Then contact your sales advisor, send us an email to info@resopal.de

or visit our homepage at www.resopal.de

Technical information is provided for you there.

DETAILS OF MATERIAL COMBINATIONS

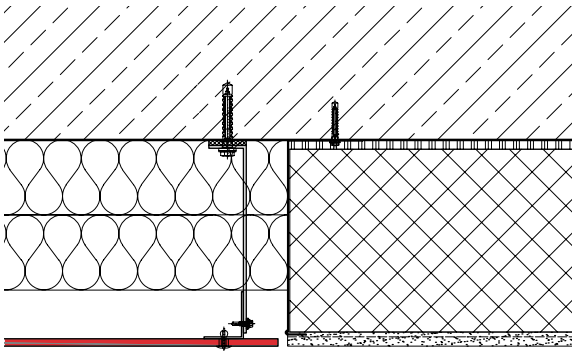

Flat, horizontal transition

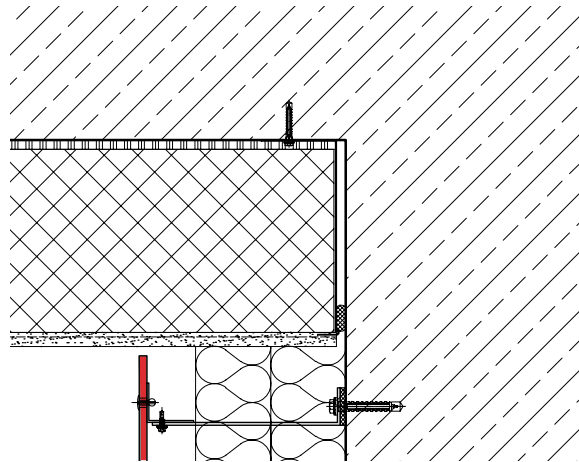

Internal Corner

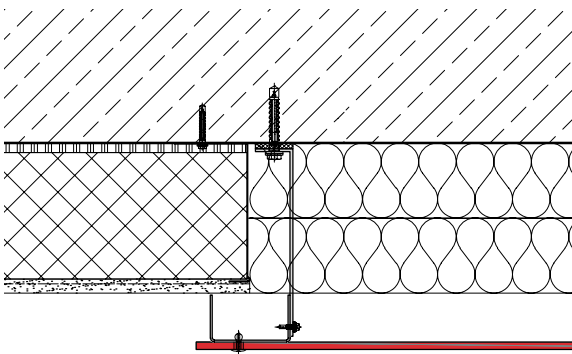

Offset, horizontal transition

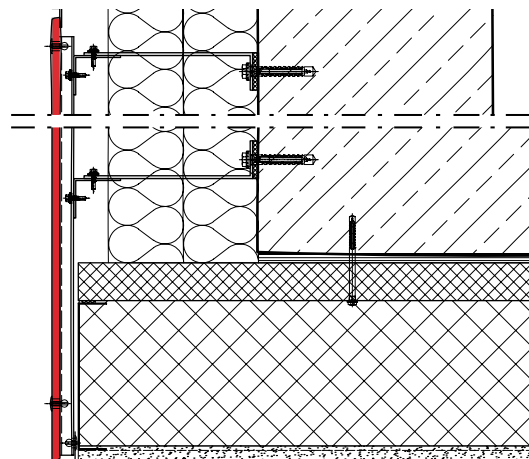

External Corner

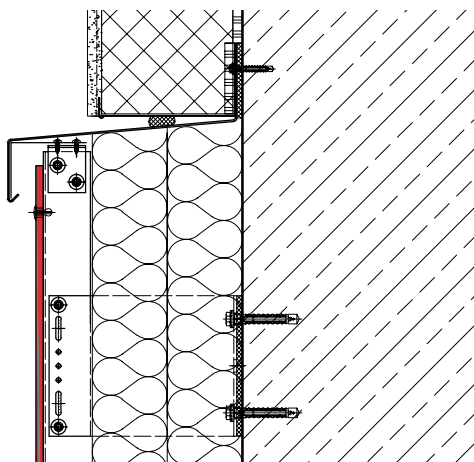

Vertical transition, RESOPLAN beneath

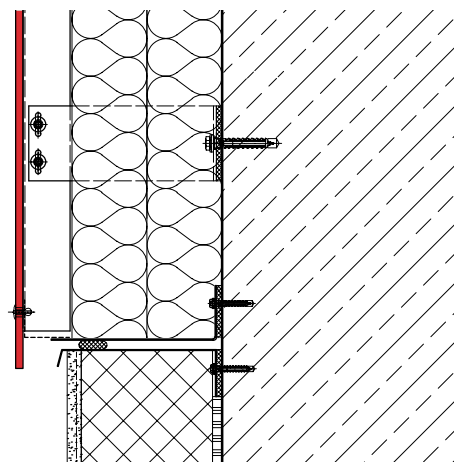

Vertical transition, RESOPLAN above



X.

FACADE SECTIONS

Thanks to its very good and economic workability, RESOPLAN is ideal for cladding different facade sections such as roof edges and dormers. It gives every building an individual look and minimises the maintenance and care work for the respective parts of the building.

GENERAL INFORMATION

The types of fixing specified in the National Technical Approval have to be used analogously to the facade application. This includes the following facade screws, which are available in colours to match the facade board:

- MBE facade screws, 5.5 x ≥ 35 mm for board thicknesses from 6 to 12 mm

For horizontal installations, the distances between fixings corresponding to the requirements of the National Technical Approval have to be selected.

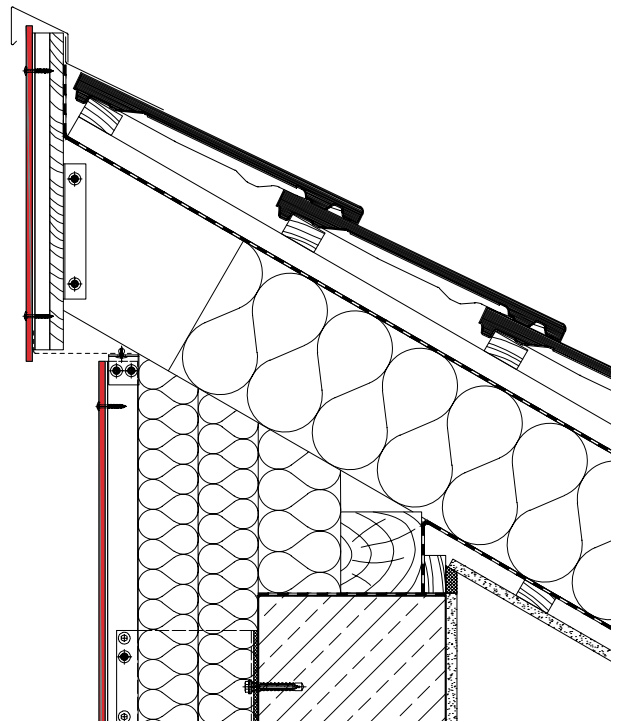

Roof ridge

DETAILS OF THE FACADE SECTIONS

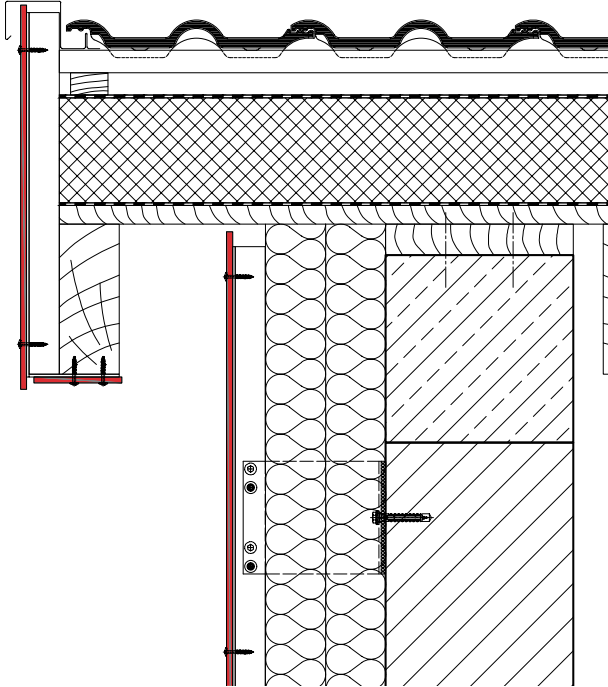

Gable end

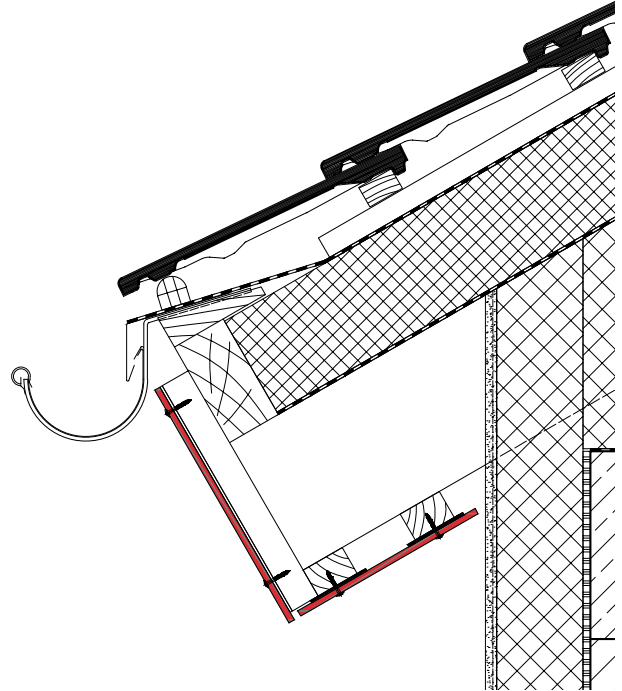

Rafter cladding, eaves

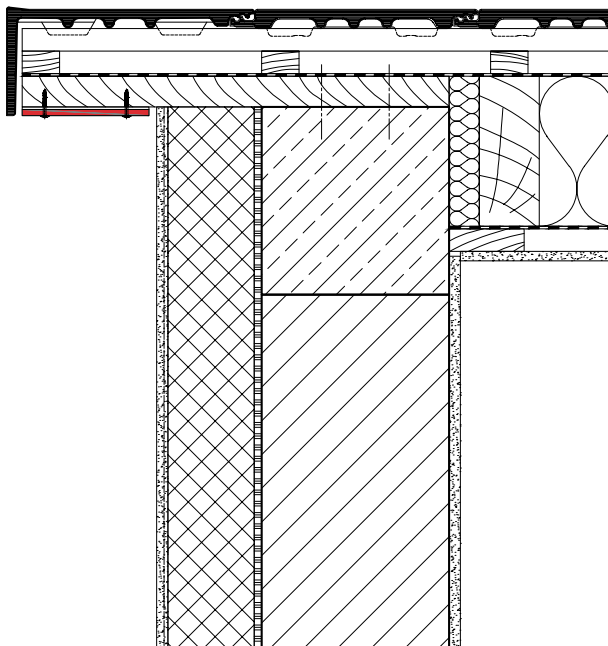

Roof overhang

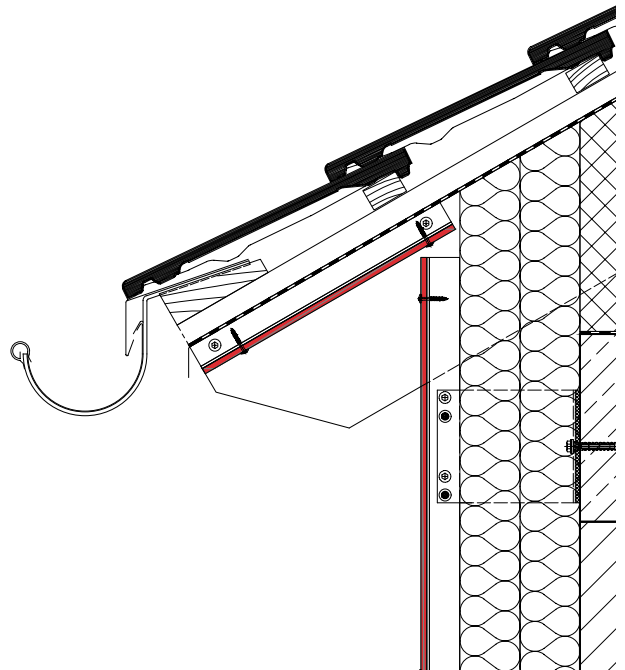

Eaves, rafters visible



XI.

CEILING CLADDING

The use of RESOPLAN as ceiling cladding outside, e.g. for entrances or recessed base storeys can also continue the materiality of the facade horizontally.

GENERAL INFORMATION

The RESOPLAN boards are fixed in the horizontal application analogously to the requirements for the vertical facade application. Because of possible moisture on the back of the board, an aluminium base structure is recommended. A sufficient movement possibility between the board and the horizontal profiles must also be ensured. The same fixings can be used as for the vertical application. The arrangement of the fixed and sliding points is also analogous.

-  Fixing point
-  Sliding point

H = Horizontal fixing distance
V = Vertical fixing distance
G = Distance from edge to fixing
≥ 20 mm and ≤ 10 x board thickness

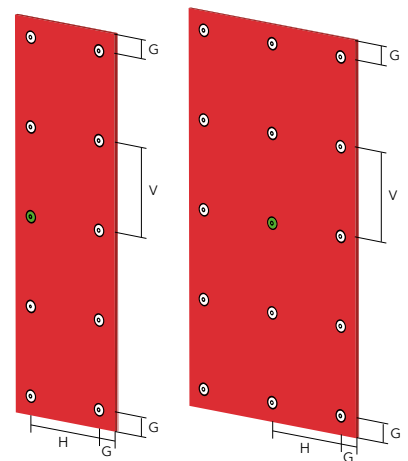

Arrangement of fixing and sliding points on vertical application

DISTANCES BETWEEN FIXINGS

The maximum distance between fixings (H and V) of 400 mm for 6 mm boards, 460 mm for 8 mm and 520 mm for 10 mm and 12 mm boards must not be exceeded. For horizontal installation, the requirements of the National Technical Approval for the distances between fixings in ceiling cladding outside must be observed.

DETAILS OF CEILING CLADDING

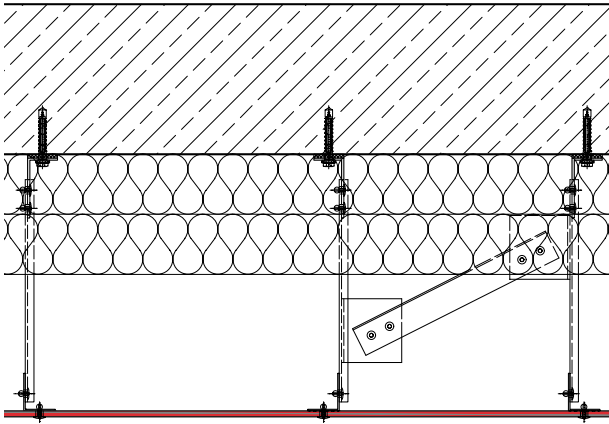

Adjustment range

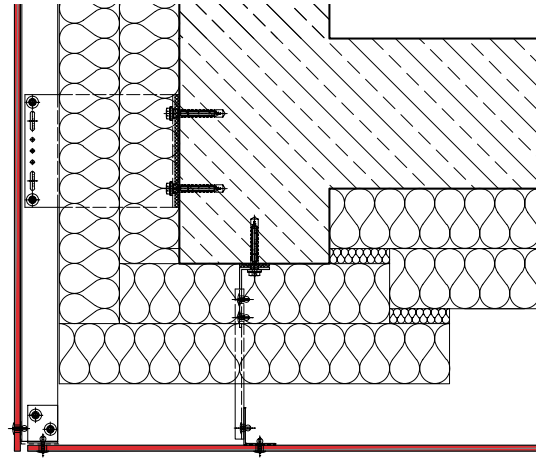

Connection to rising parts of building

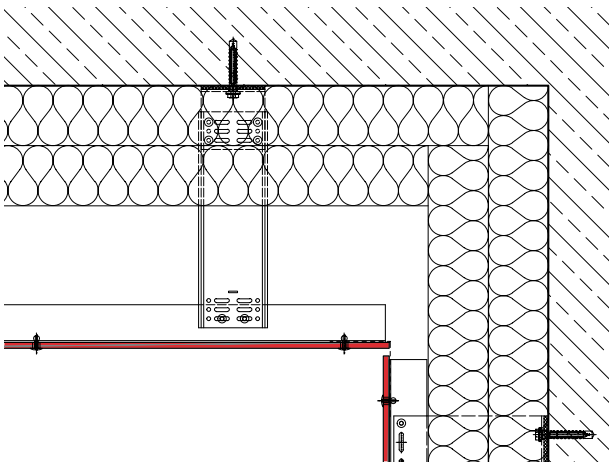

Side connection to wall

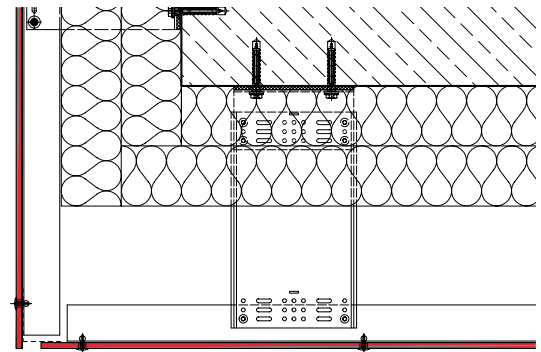

Side connection to rising parts of building



XII.

BALCONIES

RESOPLAN boards are suitable for all types of balustrade cladding because of its easy processing and its high load-bearing capacity.

GENERAL INFORMATION

RESOPLAN has been tested according to the ETB Guideline "Building components that protect against falling" in various installation situations for hard and soft impact loads and has the corresponding ETB test certificates. The Model Building Code specifies the minimum heights of guards and the maximum opening widths of guards. The building regulations of the individual states may contain different regulations. Horizontal cavities in the balustrade cladding should be avoided (ladder effect). When positioning, the horizontal opening must not be higher than 20 mm. Please note the respective ETB test certificates during installation.

Minimum guard heights according to MBO:

Fall height	Minimum guard height (h)
1 m - 12 m	0.90 m
> 12 m	1.10 m

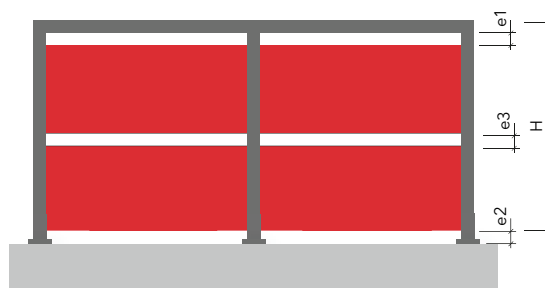
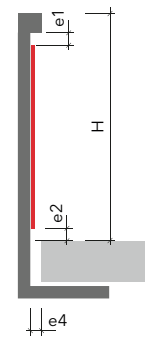
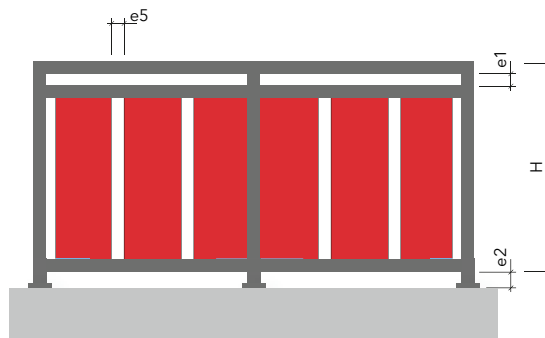

Maximum opening widths according to MBO:

e1	120 mm
e2	40 mm
e3	20 mm
e4	40 mm
e5	120 mm

FIXING WITH RIVETS OR SCREWS

Different balcony screws and rivets in board colours are available from specialist retailers. In order to ensure the movement possibility for the boards on the base structure, one fixed point and multiple sliding points have to be positioned on each board. The property-related structural calculation has to be observed here. The joints between the balcony boards and the panel joint must be at least 10 mm. For large board formats, a second fixed point may be necessary in order to support the board's dead weight.

Fixings for steel or stainless steel structures

Balcony screw

- MBE Balcony safety screw set with cap nut or sleeve (A2 quality)
M5 x length (depending on the clamping range), head diameter 16 mm

Balcony rivet

- MBE facade rivet niro/niro: 5.0 x 16/18/21, Clamping lengths: 9 - 11 mm / 11 - 13 mm / 13 - 15 mm, head diameter 16 mm

Fixings for aluminium structures

- MBE facade rivet alu/niro: 5.0 x 6/18/21, Clamping lengths: 7 - 10.5 mm / 9 - 12.5 mm / 12.0 - 15.5 mm, head diameter 16 mm

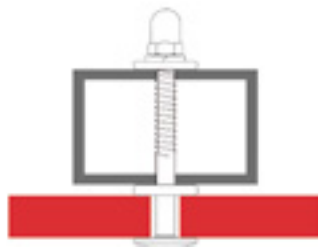

Fixed point

Sliding point

DISTANCES BETWEEN FIXINGS

Rivet fixing	Board thickness		
	6 mm	8 mm	10/12 mm
Single-field board			
Distance between fixings A [mm]: Distance to supporting profiles	600	800	950
Distance between fixings B [mm]: Distance to fixing points	500	550	550
Multiple-field board			
Distance between fixings A [mm]: Distance to supporting profiles	700	1000	1200
Distance between fixings B [mm]: Distance to fixing points	500	650	800

Screw fixing	Board thickness		
	6 mm	8 mm	10/12 mm
Single-field board			
Distance between fixings A [mm]: Distance to supporting profiles	600	800	950
Distance between fixings B [mm]: Distance to fixing points	500	650	550
Multiple-field board			
Distance between fixings A [mm]: Distance to supporting profiles	700	1050	1200
Distance between fixings B [mm]: Distance to fixing points	500	850	800

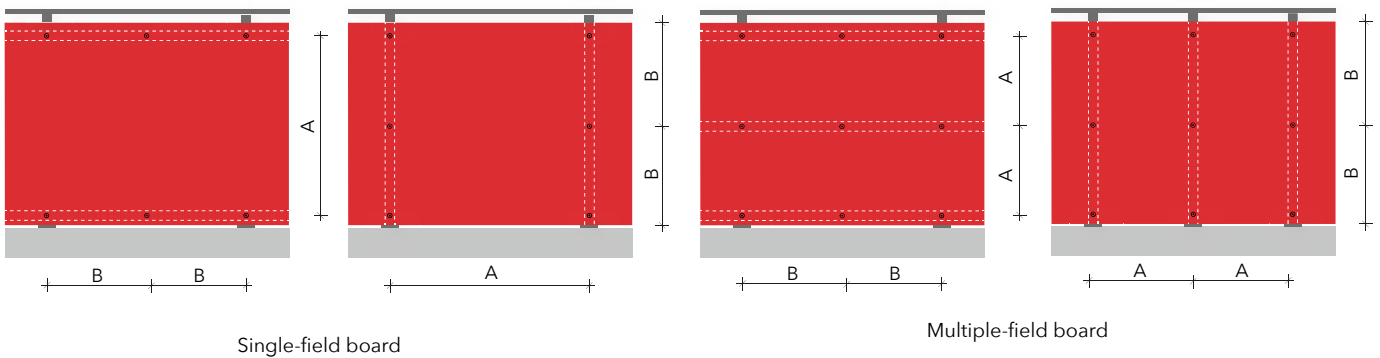

FIXING PANEL-FORMAT BALCONY CLADDING

Rivet or screw fixing of panel-format cladding	10 mm	12 mm
Single-field board		
Distance between fixings A [mm]: Distance to supporting profiles	800	1000
Multiple-field board		
Distance between fixings A [mm]: Distance to supporting profiles	1000	1300

The height of the panel-format cladding elements is 150 mm. The length of 3660 mm should not be exceeded. Balcony rivets or balcony screws are used as fixings.

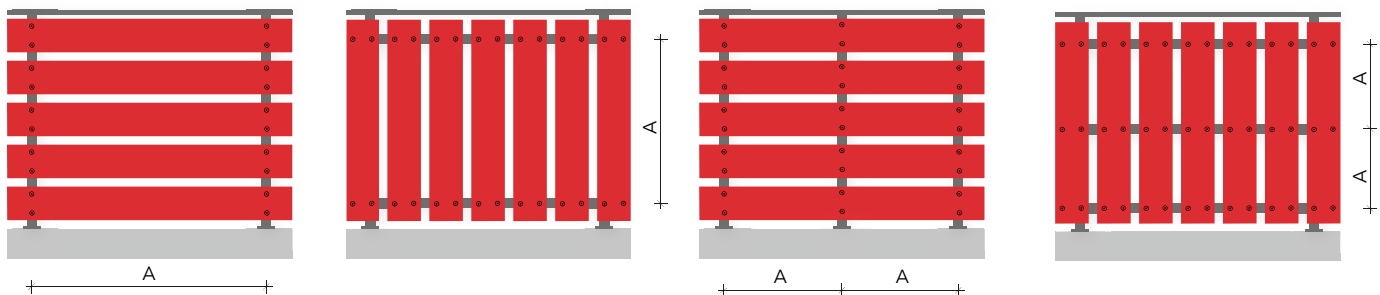

FIXING WITH STRAPS AND SCREWS

Fixing with straps and screws	8 mm
Distance between fixings A [mm]: Distance to fixings points	810
Distance between fixings B [mm]: Distance to fixings points	800

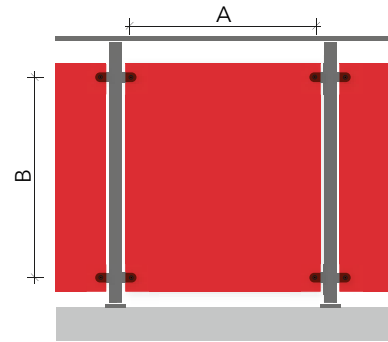

Fixing with straps

FIXING WITH PANEL FRAME

Fixing with panel frame	6 mm	8 mm	10/12 mm
Secured on two sides			
Distance between fixings B [mm]: Distance to panel frames	650	800	1000
Distance between fixings A [mm]	1000	1000	1000



Fixing with panel frame and rubber spring

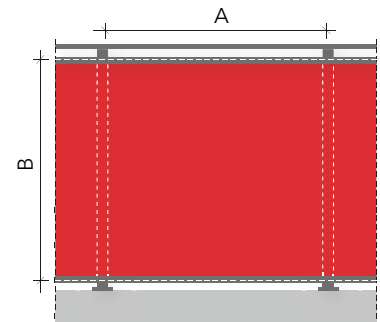

Fixing with panel frame, secured on two sides

Secured on four sides

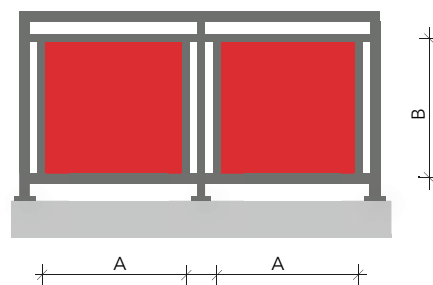
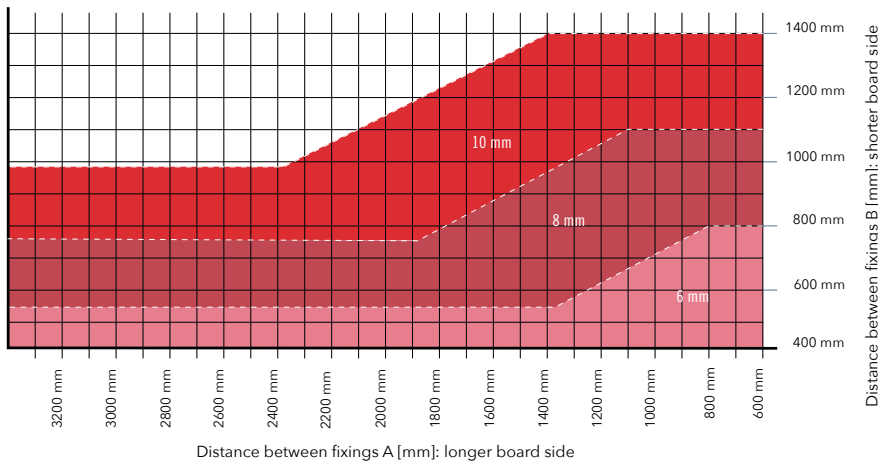

Fixing with panel frame, secured on four sides

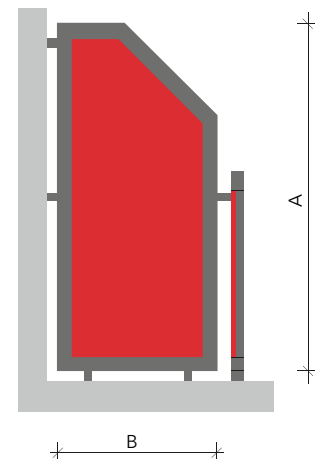

Fixing with panel frame, secured on four sides



XIII.

SUN PROTECTION

Cut into strips, RESOPLAN boards can become effective sun protection, thereby contributing to a pleasant room climate.

GENERAL INFORMATION

Sun protection slats are installed with fixed and sliding points in order to hold the sun protection elements in place and to ensure the necessary movement possibility for longitudinal expansion.

For steel structures, fixings, for example from MBE (MBE facade rivet niro/niro 5.0 x 16/18/21 mm, head diameter 16 mm), in the colour of the facade boards can be used. It is recommended that the elements are not fixed entirely over the structure. The boards have to be installed with bilateral ventilation.

FIXED AND SLIDING POINTS

Fixed point

The fixed point serves to transfer the dead weight of the slats into the base structure. A sun protection slat is typically fixed with one fixed point in the middle of the slat. The diameter of the drill hole is 5.1 mm.

Sliding point

The wind loads of can be transferred safely through the sliding point into the base structure and the sliding point allows the boards to move due to changes in shape resulting from temperature and moisture. The drill hole diameter of the sliding points is 8.5 mm. At least three fixing points are required along the length of the boards.

DO YOU HAVE ANY QUESTIONS?

Then contact your sales advisor, send us an email to

info@resopal.de

or visit our homepage at

www.resopal.de

Technical information is provided for you there.

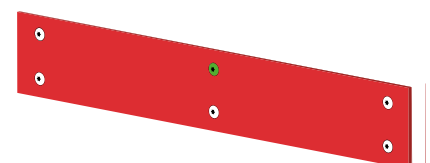

 Fixed point

 Sliding point

Open joints

In order to absorb the expansion in the plane of the boards, a joint of 8 mm is required at the panel joint and at joints to other parts of the building.

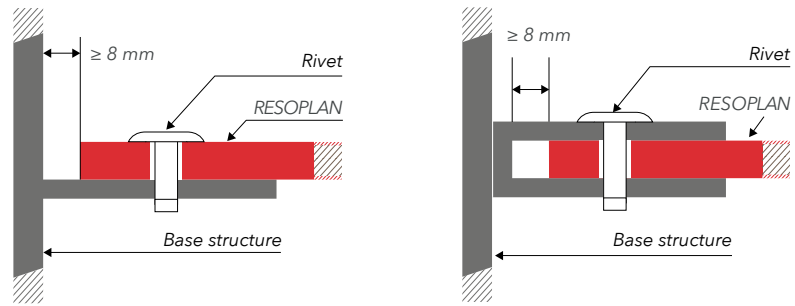

FIXING

Rivets for fixing board slats

- Material: Aluminium alloy and stainless steel shaft, at least A2, for fixing to steel and stainless steel base structure, e.g. MBE facade rivet niro/niro 5.0 x 16/18/21 mm, head diameter 16 mm
- Head painted in the colours of the boards
- Equivalent rivets or those with at least equivalent properties may be used.



Distance between fixings

The distances between fixing points depend on the length and width of the slats and on the exposure to wind and the structural system. The slats can be installed on a frame or inserted into a frame.

If the slats are installed in a frame, holes have to be drilled in them in order to allow water to drain.

SUPPORTING DISTANCES

Thickness	Width (B)	Thickness between fixings
8 mm	120 mm ≤ B ≤ 200 mm	A ≤ 600 mm
10 mm		A ≤ 700 mm
12 mm		A ≤ 800 mm

For spans larger than those in the above table, the slats must be fixed to a metal supporting structure.

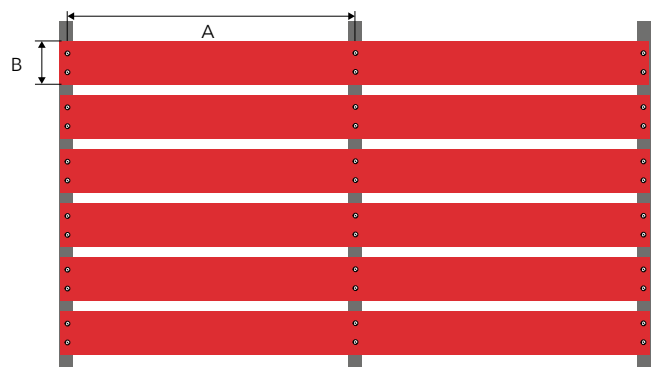

XIV.

WINDOW SHUTTERS

Window shutters made from RESOPLAN can be used as a complement to the facade or alone as an accent on the wall of the building.

GENERAL INFORMATION

RESOPLAN boards in thicknesses 8 mm, 10 mm or 12 mm can be used as window shutters. As a solid or perforated board, they are long-lasting and require only limited maintenance.

The supporting structure and the connecting system, on which the laminate boards are mounted, must have a sufficient load-bearing capacity and be sufficiently resistant to weather influences. The boards can be mounted on a supporting frame or inserted into a frame that carries the boards.

Perforation

When perforating the boards, it must be ensured that its load-bearing capacity is retained. The perforations are made in rows according to a square pattern. The perforations follow this rule: $a/b/c \geq d$.

- a = Distance from the vertical edge
- b = Distance from the horizontal edge
- c = Distance between two holes
- d = Diameter of the hole

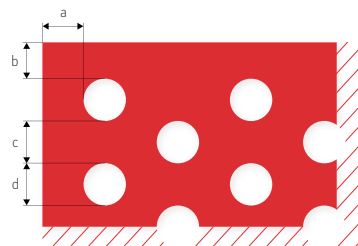
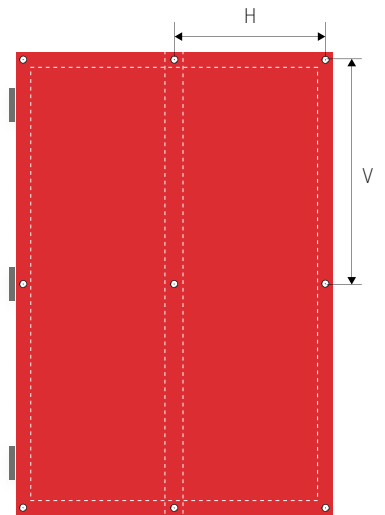
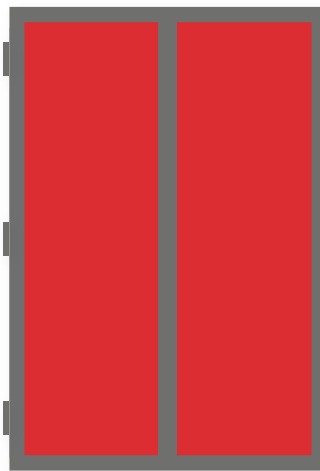

Diameter of the standard holes:
25 mm, 30 mm, 40 mm, 49 mm

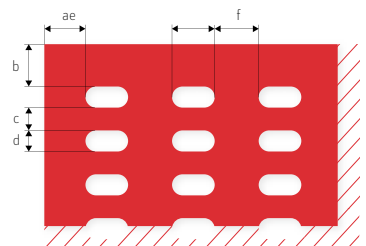

$f \geq e$

FIXING

Steel or stainless steel structure

When installing on a frame, the boards are fixed with fixed and sliding points. Fixings, for example from MBE (MBE facade rivet niro/niro 5.0 x 16/18/21 mm, head diameter 16 mm, can be used. The diameter of the drill hole of the fixed point corresponds to 5.1 mm. For sliding points, the fixing point is drilled with a diameter of 10 mm. The distance from the fixings to the end of the board is at least 20 mm and must not exceed 20-times the thickness of the board.

If you have any questions about specific drill holes, please contact the Technical Service at Resopal.

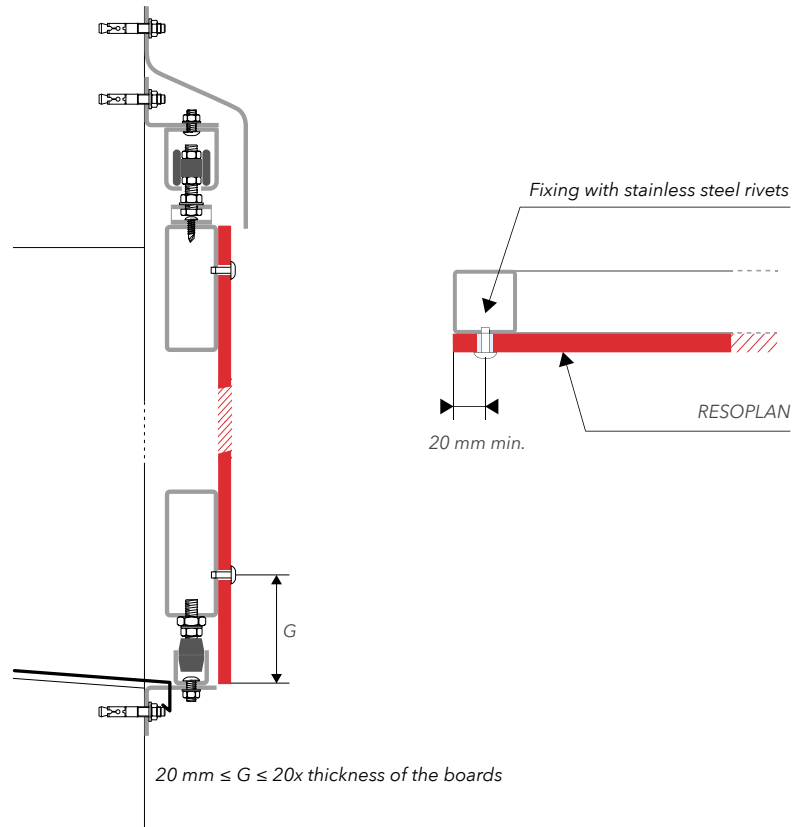

DO YOU HAVE ANY QUESTIONS?
 Then contact your sales advisor, send us an email to info@resopal.de
 or visit our homepage at www.resopal.de
 Technical information is provided for you there.

System frame

The rails that hold the boards must have clearance on both sides of at least 4 mm. The fixed position of the panel must be ensured with a rubber spring as sealing joint. There must be clearance of 8 mm to the upper system frame. The lower profile must have perforations to allow water to drain.

The boards must be fixed in place over a length of at least 20 mm per fixing point.

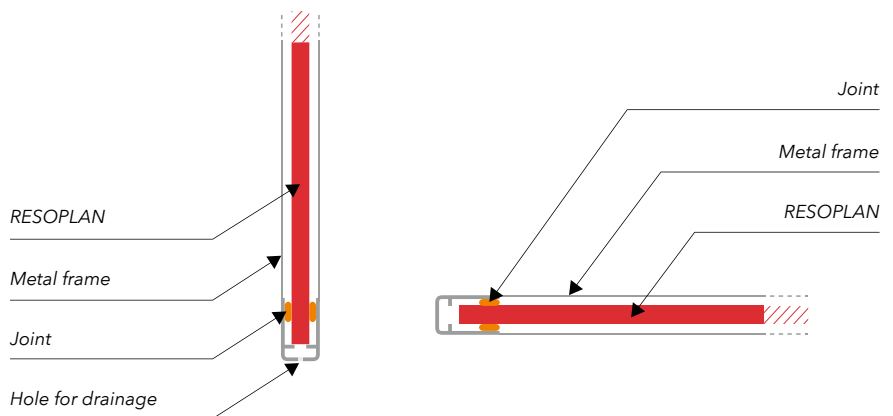

Thickness	H	V
8 mm	≤ 600 mm	≤ 600 mm
10 mm	≤ 650 mm	≤ 650 mm
12 mm	≤ 750 mm	≤ 750 mm

The table values apply to wind loads of 600 Pa.

H = Horizontal distance between fixings V = Vertical distance between fixings

SOURCES OF SUPPLY FOR RESOPLAN ACCESSORIES

Fixing elements

MBE GmbH
Siemensstraße 1
58706 Menden
Germany
Tel.: +49 (0) 23 73 / 17 43 00
Fax: +49 (0) 23 73 /17 43 01 1
E-Mail: info@mbe-gmbh.de
Internet: www.mbe-gmbh.de

TECHNICAL STATUS 2018

All instructions, also information in drawings, correspond to the current technical status and the experience based on it. The uses shown as examples and cannot take the features of the individual case into account. The suitability of the material for the planned use must be on site, Resopal GmbH's liability is excluded. This also applies to printing errors and subsequent changes to technical details.

